

Symantec NetBackup™ Appliance Fibre Channel Guide

Release 2.6.1.2

NetBackup 52xx and 5330



Symantec NetBackup™ Appliance Fibre Channel Guide

Documentation version: 2.6.1.2

Legal Notice

Copyright © 2015 Symantec Corporation. All rights reserved.

Symantec, the Symantec Logo, the Checkmark Logo, NetBackup, and Veritas are trademarks or registered trademarks of Symantec Corporation or its affiliates in the U.S. and other countries. Other names may be trademarks of their respective owners.

This Symantec product may contain third party software for which Symantec is required to provide attribution to the third party ("Third Party Programs"). Some of the Third Party Programs are available under open source or free software licenses. The License Agreement accompanying the Software does not alter any rights or obligations you may have under those open source or free software licenses. Please see the Third Party Legal Notice Appendix to this Documentation or TPIP ReadMe File accompanying this Symantec product for more information on the Third Party Programs.

The product described in this document is distributed under licenses restricting its use, copying, distribution, and decompilation/reverse engineering. No part of this document may be reproduced in any form by any means without prior written authorization of Symantec Corporation and its licensors, if any.

THE DOCUMENTATION IS PROVIDED "AS IS" AND ALL EXPRESS OR IMPLIED CONDITIONS, REPRESENTATIONS AND WARRANTIES, INCLUDING ANY IMPLIED WARRANTY OF MERCHANTABILITY, FITNESS FOR A PARTICULAR PURPOSE OR NON-INFRINGEMENT, ARE DISCLAIMED, EXCEPT TO THE EXTENT THAT SUCH DISCLAIMERS ARE HELD TO BE LEGALLY INVALID. SYMANTEC CORPORATION SHALL NOT BE LIABLE FOR INCIDENTAL OR CONSEQUENTIAL DAMAGES IN CONNECTION WITH THE FURNISHING, PERFORMANCE, OR USE OF THIS DOCUMENTATION. THE INFORMATION CONTAINED IN THIS DOCUMENTATION IS SUBJECT TO CHANGE WITHOUT NOTICE.

The Licensed Software and Documentation are deemed to be commercial computer software as defined in FAR 12.212 and subject to restricted rights as defined in FAR Section 52.227-19 "Commercial Computer Software - Restricted Rights" and DFARS 227.7202, et seq. "Commercial Computer Software and Commercial Computer Software Documentation," as applicable, and any successor regulations, whether delivered by Symantec as on premises or hosted services. Any use, modification, reproduction release, performance, display or disclosure of the Licensed Software and Documentation by the U.S. Government shall be solely in accordance with the terms of this Agreement.

Symantec Corporation
350 Ellis Street
Mountain View, CA 94043

<http://www.symantec.com>

Technical Support

Symantec Technical Support maintains support centers globally. Technical Support's primary role is to respond to specific queries about product features and functionality. The Technical Support group also creates content for our online Knowledge Base. The Technical Support group works collaboratively with the other functional areas within Symantec to answer your questions in a timely fashion. For example, the Technical Support group works with Product Engineering and Symantec Security Response to provide alerting services and virus definition updates.

Symantec's support offerings include the following:

- A range of support options that give you the flexibility to select the right amount of service for any size organization
- Telephone and/or Web-based support that provides rapid response and up-to-the-minute information
- Upgrade assurance that delivers software upgrades
- Global support purchased on a regional business hours or 24 hours a day, 7 days a week basis
- Premium service offerings that include Account Management Services

For information about Symantec's support offerings, you can visit our website at the following URL:

www.symantec.com/business/support/

All support services will be delivered in accordance with your support agreement and the then-current enterprise technical support policy.

Contacting Technical Support

Customers with a current support agreement may access Technical Support information at the following URL:

www.symantec.com/business/support/

Before contacting Technical Support, make sure you have satisfied the system requirements that are listed in your product documentation. Also, you should be at the computer on which the problem occurred, in case it is necessary to replicate the problem.

When you contact Technical Support, please have the following information available:

- Product release level
- Hardware information

- Available memory, disk space, and NIC information
- Operating system
- Version and patch level
- Network topology
- Router, gateway, and IP address information
- Problem description:
 - Error messages and log files
 - Troubleshooting that was performed before contacting Symantec
 - Recent software configuration changes and network changes

Licensing and registration

If your Symantec product requires registration or a license key, access our technical support Web page at the following URL:

www.symantec.com/business/support/

Customer service

Customer service information is available at the following URL:

www.symantec.com/business/support/

Customer Service is available to assist with non-technical questions, such as the following types of issues:

- Questions regarding product licensing or serialization
- Product registration updates, such as address or name changes
- General product information (features, language availability, local dealers)
- Latest information about product updates and upgrades
- Information about upgrade assurance and support contracts
- Information about the Symantec Buying Programs
- Advice about Symantec's technical support options
- Nontechnical presales questions
- Issues that are related to CD-ROMs, DVDs, or manuals

Support agreement resources

If you want to contact Symantec regarding an existing support agreement, please contact the support agreement administration team for your region as follows:

Asia-Pacific and Japan customercare_apac@symantec.com

Europe, Middle-East, and Africa semea@symantec.com

North America and Latin America supportsolutions@symantec.com

Contents

Technical Support	4	
Chapter 1	Overview	9
	Supported data transfer methods for NetBackup appliances	9
	About Fibre Channel port configuration options for the NetBackup 52xx appliances	11
	Supported PCIe card and Fibre Channel options for the NetBackup 5330 appliance	18
	About backup to tape support for NetBackup appliances	22
Chapter 2	SAN Client and Fibre Transport Support	23
	About NetBackup SAN Client and Fibre Transport	23
	About the SAN Client license key	25
	About zoning the SAN for NetBackup appliances	25
	Settings > Network > Fibre Transport	28
	Changing the Fibre Transport settings	30
	Guidelines for changing NetBackup appliance FT target ports to receive data streams from multiple SAN Client FC initiator ports	32
	About Fibre Transport paths for NetBackup appliances	33
	How to determine appliance HBA WWPNs	38
	How to configure two NetBackup 52xx or 5330 appliances in different domains for MSDP replication	39
	Configuring direct backups from a NetBackup 52xx or 5330 appliance to a NetBackup 50xx appliance using Fibre Channel	40
Chapter 3	VMware support	43
	About the NetBackup appliance as a VMware backup host	43
	Appliance as backup host: component overview	44
	Notes on the NetBackup appliance as a VMware backup host	44
	About appliance dynamic multipathing for VMware backups with SAN transport	45

Index 46

Overview

This chapter includes the following topics:

- [Supported data transfer methods for NetBackup appliances](#)
- [About Fibre Channel port configuration options for the NetBackup 52xx appliances](#)
- [Supported PCIe card and Fibre Channel options for the NetBackup 5330 appliance](#)
- [About backup to tape support for NetBackup appliances](#)

Supported data transfer methods for NetBackup appliances

[Table 1-1](#) describes the supported data transfer methods between NetBackup appliances. Specifically, NetBackup deduplication appliance models 5020 or 5030 and NetBackup appliance models 5220, 5230, or 5330. The information includes whether the supported method uses Fibre Channel (FC) or TCP/IP.

Table 1-1 Supported data transfer methods for NetBackup appliances

No.	Method	Source	Target	Operation
1	FC	52xx/5330	5020/5030	Optimized duplication (See note below table.)
2	FC	52xx/5330	5020/5030	Auto Image Replication. (See note below table.)
3	FC	5020/5030	5020/5030	Optimized duplication
4	FC	5020/5030	5020/5030	Auto Image Replication.

Table 1-1 Supported data transfer methods for NetBackup appliances (*continued*)

No.	Method	Source	Target	Operation
5	FC	SAN Client	52xx/5330	Media server deduplication
6	TCP/IP	52xx/5330	52xx/5330	Optimized duplication
7	TCP/IP	52xx/5330	52xx/5330	Auto Image Replication.
8	TCP/IP	52xx/5330	5020/5030	Optimized duplication
9	TCP/IP	52xx/5330	5020/5030	Auto Image Replication.
10	TCP/IP	5020/5030	5020/5030	Optimized duplication
11	TCP/IP	5020/5030	5020/5030	Auto Image Replication.

Note: For deduplication operations, the 5220, 5230, and the 5330 appliances can also leverage FC connectivity to directly communicate with the 5020 and 5030 appliances. For more information, refer to the following topic:

See [“Configuring direct backups from a NetBackup 52xx or 5330 appliance to a NetBackup 50xx appliance using Fibre Channel”](#) on page 40.

Table 1-2 describes the unsupported data transfer methods for NetBackup Deduplication and NetBackup appliances.

Table 1-2 Unsupported data transfer methods for NetBackup appliances

No.	Method	Source	Target	Operation
1	FC	52xx/5330	52xx/5330	Optimized duplication
2	FC	52xx/5330	52xx/5330	Auto Image Replication.
3	FC	5020/5030	52xx/5330	Optimized duplication
4	FC	5020/5030	52xx/5330	Auto Image Replication.
5	FC	SAN Client	5020/5030	Client deduplication
6	TCP/IP	5020/5030	52xx/5330	Optimized duplication
7	TCP/IP	5020/5030	52xx/5330	Auto Image Replication.

About Fibre Channel port configuration options for the NetBackup 52xx appliances

The NetBackup 52xx appliances support the use of Fibre Channel (FC) with the following features:

- SAN Client

This feature provides high-speed backups and restores of NetBackup clients. A SAN client is a special NetBackup client that can back up large amounts of data rapidly over a SAN connection rather than a LAN. The backup and restore traffic occurs over FC, and the NetBackup server and client administration traffic occurs over the LAN.

For information about how to configure a NetBackup 5220 or 5230 to work with the SAN Client feature, refer to the following topics:

See [“About Fibre Transport paths for NetBackup appliances”](#) on page 33.

See [“How to determine appliance HBA WWPNS”](#) on page 38.
- Optimized duplication to a NetBackup 5020 or 5030

Optimized duplication copies the backup images from a NetBackup 5220 or 5230 appliance (source) to a NetBackup 5020 or 5030 appliance (destination). The source and the destination must use the same NetBackup master server. The optimized duplication operation is more efficient than normal duplication because only the unique, deduplicated data segments are transferred. Optimized duplication reduces the amount of data transmission over your network and is a good method to copy your backup images off-site for disaster recovery.

For information about how to configure a NetBackup 5220 or 5230 for optimized duplication to a NetBackup 5020 or 5030 deduplication appliance, refer to the following topics:

See [“About Fibre Transport paths for NetBackup appliances”](#) on page 33.

See [“How to determine appliance HBA WWPNS”](#) on page 38.

For complete details about the NetBackup 5020 and 5030 appliances, see the *Symantec NetBackup Deduplication Appliance Software Administrator's Guide*.
- NetBackup for VMware

This feature provides backup and restore of the VMware virtual machines that run on VMware ESX servers. NetBackup for VMware takes advantage of VMware vStorage APIs for data protection. The backup process is off-loaded from the ESX server to a VMware backup host.

Starting with NetBackup 52xx appliance software version 2.5, you can use the appliance as a VMware backup host. Earlier software versions required a separate Windows system as the host.

For information about how to configure a NetBackup 5220 or 5230 as a VMware backup host, refer to the following topics:

See [“About the NetBackup appliance as a VMware backup host”](#) on page 43.
See [“Notes on the NetBackup appliance as a VMware backup host”](#) on page 44.
For complete details about NetBackup for VMware and how to configure VMware policies, see the *Symantec NetBackup for VMware Administrator's Guide*.

- Tape out

NetBackup appliances support backups to tape so that you can connect one or more tape libraries to them with FC. An FC host bus adapter (HBA) provides for connection to a TLD tape storage device.

For information about how to configure a NetBackup 5220 or 5230 for backups to tape, refer to the following topics:

See [“About backup to tape support for NetBackup appliances”](#) on page 22.

[Figure 1-1](#) describes the supported FC HBA slot locations and the port order for the installed FC HBA cards.

On a NetBackup 5220, slots 2 - 4 support FC. On a NetBackup 5230, slots 2 - 6 support FC.

About Fibre Channel port configuration options for the NetBackup 52xx appliances

Figure 1-1 NetBackup 5220 and 5230 FC HBA slots and ports

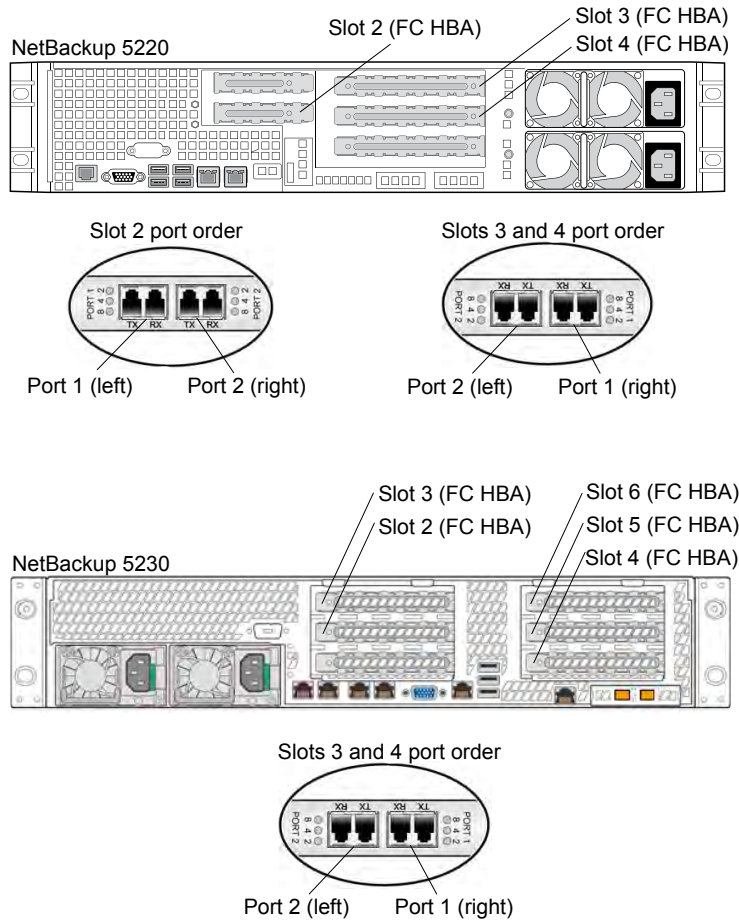

The following provides a summary of the supported NetBackup 5220 and 5230 FC options. The 5220 and 5230 slot location and the required port configuration for each option are also included.

Table 1-3 Summary of supported NetBackup 5220 and 5230 FC options

FC HBA slot	Supported options and required port configuration
<p>Slot 2 (5220 and 5230)</p>	<p>Port 1</p> <ul style="list-style-type: none"> ■ SAN Client - target (5220 only) <p>All FC HBA ports on the NetBackup 5220 appliance default to the initiator mode. To use the SAN Client option on this port, the SAN Client FT media server feature must be enabled. The target port option can be set to either 2 target port Fibre Channel connection or 4 target port Fibre Channel connection. When you enable this feature, Port 1 on the FC HBA cards in slots 2 and 4 is changed to the target mode. To use the SAN Client feature, Port 1 on both of the FC HBA cards in these slots must be used.</p> <p>See “Settings > Network > Fibre Transport” on page 28. See “Changing the Fibre Transport settings” on page 30.</p> <p>Note: The NetBackup 5230 appliance does not support SAN Client on slot 2.</p> ■ Tape out - initiator ■ NetBackup for VMware - initiator <p>Port 2</p> <ul style="list-style-type: none"> ■ SAN Client - target (5220 only) <p>All FC HBA ports on the NetBackup 5220 appliance default to the initiator mode. To use the SAN Client option on this port, the SAN Client FT media server feature must be enabled and set to the 4 target port Fibre Channel connection option. When you enable this feature, Port 1 and Port 2 on the FC HBA cards in slots 2 and 4 are changed to the target mode. To use the SAN Client feature, Port 1 and Port 2 on both of the FC HBA cards in these slots must be used.</p> <p>Note: If Port 1 is in the initiator mode, Port 2 cannot be set to the target mode. Port 2 can only be configured for the target mode when the 4 target port Fibre Channel connection option is selected.</p> <p>See “Settings > Network > Fibre Transport” on page 28. See “Changing the Fibre Transport settings” on page 30.</p> ■ Optimized duplication (FT storage zone) - initiator ■ Tape out - initiator ■ NetBackup for VMware - initiator <p>Use only one option on each port.</p>

Table 1-3 Summary of supported NetBackup 5220 and 5230 FC options
(continued)

FC HBA slot	Supported options and required port configuration
Slot 3 (5220 and 5230)	<p>Port 1</p> <ul style="list-style-type: none"> ■ Tape out - initiator ■ NetBackup for VMware - initiator <p>Port 2</p> <ul style="list-style-type: none"> ■ Tape out - initiator ■ NetBackup for VMware - initiator <p>Use only one option on each port.</p>

Table 1-3 Summary of supported NetBackup 5220 and 5230 FC options
(continued)

FC HBA slot	Supported options and required port configuration
Slot 4 (5220 and 5230)	<p>Port 1</p> <ul style="list-style-type: none"> ■ SAN Client - target (5220 only) All FC HBA ports on the NetBackup 5220 appliance default to the initiator mode. To use the SAN Client option on this port, the SAN Client FT media server feature must be enabled. The target port option can be set to either 2 target port Fibre Channel connection or 4 target port Fibre Channel connection. When you enable this feature, Port 1 on the FC HBA cards in slots 2 and 4 is changed to the target mode. To use the SAN Client feature, Port 1 on both of the FC HBA cards in these slots must be used. See “Settings > Network > Fibre Transport” on page 28. See “Changing the Fibre Transport settings” on page 30. Note: The NetBackup 5230 appliance does not support SAN Client on slot 4. ■ Tape out - initiator ■ NetBackup for VMware - initiator <p>Port 2</p> <ul style="list-style-type: none"> ■ SAN Client - target (5220 only) All FC HBA ports on the NetBackup 5220 appliance default to the initiator mode. To use the SAN Client option on this port, the SAN Client FT media server feature must be enabled and set to the 4 target port Fibre Channel connection option. When you enable this feature, Port 1 and Port 2 on the FC HBA cards in slots 2 and 4 are changed to the target mode. To use the SAN Client feature, Port 1 and Port 2 on both of the FC HBA cards in these slots must be used. Note: If Port 1 is in the initiator mode, Port 2 cannot be set to the target mode. Port 2 can only be configured for the target mode when the 4 target port Fibre Channel connection option is selected. See “Settings > Network > Fibre Transport” on page 28. See “Changing the Fibre Transport settings” on page 30. ■ Optimized duplication (FT storage zone) - initiator ■ Tape out - initiator ■ NetBackup for VMware - initiator <p>Use only one option on each port.</p>

Table 1-3 Summary of supported NetBackup 5220 and 5230 FC options
(continued)

FC HBA slot	Supported options and required port configuration
Slots 5 - 6 (5230 only)	<p>Port 1</p> <ul style="list-style-type: none"> ■ SAN Client - target All FC HBA ports on the NetBackup 5230 appliance default to the initiator mode. To use the SAN Client option on this port, the SAN Client FT media server feature must be enabled. The target port option can be set to either 2 target port Fibre Channel connection or 4 target port Fibre Channel connection. When you enable this feature, Port 1 on the FC HBA cards in slots 5 and 6 is changed to the target mode. To use the SAN Client feature, Port 1 on both of the FC HBA cards in these slots must be used. See “Settings > Network > Fibre Transport” on page 28. See “Changing the Fibre Transport settings” on page 30. ■ Tape out - initiator ■ NetBackup for VMware - initiator <p>Port 2</p> <ul style="list-style-type: none"> ■ SAN Client - target All FC HBA ports on the NetBackup 5230 appliance default to the initiator mode. To use the SAN Client option on this port, the SAN Client FT media server feature must be enabled and set to the 4 target port Fibre Channel connection option. When you enable this feature, Port 1 and Port 2 on the FC HBA cards in slots 5 and 6 are changed to the target mode. To use the SAN Client feature, Port 1 and Port 2 on both of the FC HBA cards in these slots must be used. Note: If Port 1 is in the initiator mode, Port 2 cannot be set to the target mode. Port 2 can only be configured for the target mode when the 4 target port Fibre Channel connection option is selected. See “Settings > Network > Fibre Transport” on page 28. See “Changing the Fibre Transport settings” on page 30. ■ Tape out - initiator ■ NetBackup for VMware - initiator <p>Use only one option on each port.</p>

See [“How to determine appliance HBA WWPNs”](#) on page 38.

See [“About Fibre Transport paths for NetBackup appliances”](#) on page 33.

Supported PCIe card and Fibre Channel options for the NetBackup 5330 appliance

The NetBackup 5330 appliance contains six populated PCIe card slots. Each slot contains either a Fibre Channel (FC) HBA card or an Ethernet card.

Figure 1-2 shows the PCIe slot locations and the port order for the installed FC HBA cards.

Figure 1-2 NetBackup 5330 PCIe slot locations and FC HBA port order

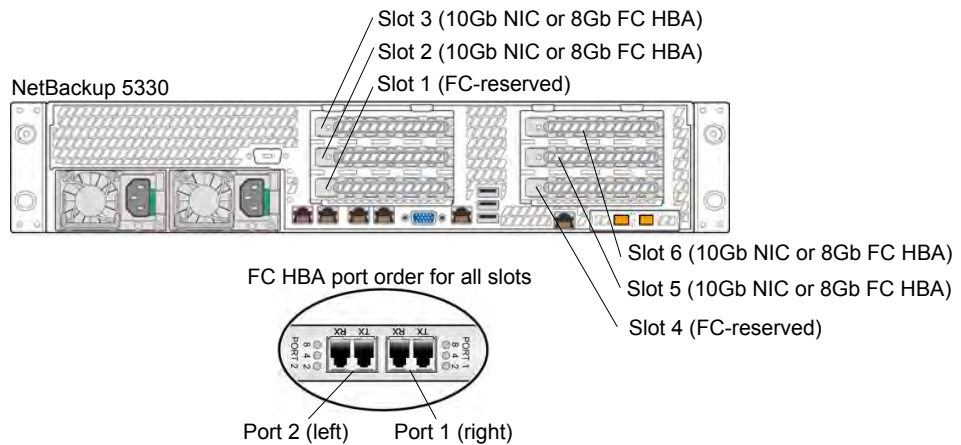

Table 1-4 describes the supported card type for each slot and the supported FC options.

Table 1-4 Supported NetBackup 5330 PCIe card slot configurations and FC options

Card slot and type	Supported FC options
Slot 1 FC HBA	Reserved exclusively for attachment to external storage (Primary Storage Shelf).

Table 1-4 Supported NetBackup 5330 PCIe card slot configurations and FC options *(continued)*

Card slot and type	Supported FC options
Slot 2 10Gb NIC or 8Gb FC HBA	Port 1 <ul style="list-style-type: none"> ■ Optimized duplication (FT storage zone) - initiator ■ Tape out - initiator ■ NetBackup for VMware - initiator Port 2 <ul style="list-style-type: none"> ■ Optimized duplication (FT storage zone) - initiator ■ Tape out - initiator ■ NetBackup for VMware - initiator Use only one option on each port.
Slot 3 10Gb NIC or 8Gb FC HBA	Port 1 <ul style="list-style-type: none"> ■ Optimized duplication (FT storage zone) - initiator ■ Tape out - initiator ■ NetBackup for VMware - initiator Port 2 <ul style="list-style-type: none"> ■ Optimized duplication (FT storage zone) - initiator ■ Tape out - initiator ■ NetBackup for VMware - initiator Use only one option on each port.
Slot 4 FC HBA	Reserved exclusively for attachment to external storage (Primary Storage Shelf).

Table 1-4 Supported NetBackup 5330 PCIe card slot configurations and FC options *(continued)*

Card slot and type	Supported FC options
<p>Slot 5</p> <p>10Gb NIC or 8Gb FC HBA</p>	<p>Port 1</p> <ul style="list-style-type: none"> ■ SAN Client - target <p>All FC HBA ports on the NetBackup 5330 appliance default to the initiator mode. To use the SAN Client option on this port, the SAN Client FT media server feature must be enabled. The target port option can be set to either 2 target port Fibre Channel connection or 4 target port Fibre Channel connection. When you enable this feature, Port 1 on the FC HBA cards in slots 5 and 6 is changed to the target mode. To use the SAN Client feature, Port 1 on both of the FC HBA cards in these slots must be used.</p> <p>See “Settings > Network > Fibre Transport” on page 28. See “Changing the Fibre Transport settings” on page 30.</p> ■ Optimized duplication (FT storage zone) - initiator ■ Tape out - initiator ■ NetBackup for VMware - initiator <p>Port 2</p> <ul style="list-style-type: none"> ■ SAN Client - target <p>All FC HBA ports on the NetBackup 5330 appliance default to the initiator mode. To use the SAN Client option on this port, the SAN Client FT media server feature must be enabled and set to the 4 target port Fibre Channel connection option. When you enable this feature, Port 1 and Port 2 on the FC HBA cards in slots 5 and 6 are changed to the target mode. To use the SAN Client feature, Port 1 and Port 2 on both of the FC HBA cards in these slots must be used.</p> <p>Note: If Port 1 is in the initiator mode, Port 2 cannot be set to the target mode. Port 2 can only be configured for the target mode when the 4 target port Fibre Channel connection option is selected.</p> <p>See “Settings > Network > Fibre Transport” on page 28. See “Changing the Fibre Transport settings” on page 30.</p> ■ Optimized duplication (FT storage zone) - initiator ■ Tape out - initiator ■ NetBackup for VMware - initiator <p>Use only one option on each port.</p>

Table 1-4 Supported NetBackup 5330 PCIe card slot configurations and FC options *(continued)*

Card slot and type	Supported FC options
<p>Slot 6</p> <p>10Gb NIC or 8Gb FC HBA</p>	<p>Port 1</p> <ul style="list-style-type: none"> ■ SAN Client - target <p>All FC HBA ports on the NetBackup 5330 appliance default to the initiator mode. To use the SAN Client option on this port, the SAN Client FT media server feature must be enabled. The target port option can be set to either 2 target port Fibre Channel connection or 4 target port Fibre Channel connection. When you enable this feature, Port 1 on the FC HBA cards in slots 5 and 6 is changed to the target mode. To use the SAN Client feature, Port 1 on both of the FC HBA cards in these slots must be used.</p> <p>See “Settings > Network > Fibre Transport” on page 28. See “Changing the Fibre Transport settings” on page 30.</p> ■ Optimized duplication (FT storage zone) - initiator ■ Tape out - initiator ■ NetBackup for VMware - initiator <p>Port 2</p> <ul style="list-style-type: none"> ■ SAN Client - target <p>All FC HBA ports on the NetBackup 5330 appliance default to the initiator mode. To use the SAN Client option on this port, the SAN Client FT media server feature must be enabled and set to the 4 target port Fibre Channel connection option. When you enable this feature, Port 1 and Port 2 on the FC HBA cards in slots 5 and 6 are changed to the target mode. To use the SAN Client feature, Port 1 and Port 2 on both of the FC HBA cards in these slots must be used.</p> <p>Note: If Port 1 is in the initiator mode, Port 2 cannot be set to the target mode. Port 2 can only be configured for the target mode when the 4 target port Fibre Channel connection option is selected.</p> <p>See “Settings > Network > Fibre Transport” on page 28. See “Changing the Fibre Transport settings” on page 30.</p> ■ Optimized duplication (FT storage zone) - initiator ■ Tape out - initiator ■ NetBackup for VMware - initiator <p>Use only one option on each port.</p>

About backup to tape support for NetBackup appliances

NetBackup appliances support backups to tape so that you can connect one or more tape libraries to them with Fibre Channel. The appliances use a Fibre Channel host bus adapter card (FC HBA) for connection to a TLD tape storage device.

On NetBackup 5330 appliances, slots 2 or 3 can be used for connection to a tape library (tape out).

If you use a tape library as storage, create a separate zone for that traffic. The tape storage zone should include the following FC HBA ports:

- A port or ports on the FC HBA card in slot 3 of a 52xx appliance.
- A port or ports on the FC HBA card in slots 2 or 3 of a 5330 appliance.
- A port or ports on the tape library.

If you duplicate backup images from a tape library to a NetBackup 5020 or 5030 deduplication appliance, traffic occurs as follows:

- Fibre Channel between the tape library and the 52xx or 5330 appliance.
- Fibre Transport between the 52xx or 5330 appliance and the 5020 or 5030 deduplication appliance.

Note: Duplication between two NetBackup 52xx or two 5330 appliances using Fibre Channel is not supported.

See [“Supported PCIe card and Fibre Channel options for the NetBackup 5330 appliance”](#) on page 18.

SAN Client and Fibre Transport Support

This chapter includes the following topics:

- [About NetBackup SAN Client and Fibre Transport](#)
- [About the SAN Client license key](#)
- [About zoning the SAN for NetBackup appliances](#)
- [Settings > Network > Fibre Transport](#)
- [About Fibre Transport paths for NetBackup appliances](#)
- [How to determine appliance HBA WWPNS](#)
- [How to configure two NetBackup 52xx or 5330 appliances in different domains for MSDP replication](#)
- [Configuring direct backups from a NetBackup 52xx or 5330 appliance to a NetBackup 50xx appliance using Fibre Channel](#)

About NetBackup SAN Client and Fibre Transport

SAN Client is a NetBackup optional feature that provides high-speed backups and restores of NetBackup clients.

Note: If you plan to use the SAN Client feature with your appliance and you have SLES 10 clients with QLogic FC HBA cards, a driver update is required. Before you proceed with backups of any SLES 10 clients, Symantec recommends that you first upgrade the QLogic driver in all SLES 10 clients to version 8.03.07.03.10.3-k or later.

A SAN client is a special NetBackup client that can back up large amounts of data rapidly over a SAN connection rather than a LAN. For example, a database host can benefit from high-speed backups and restores. Fibre Transport is the name of the NetBackup high-speed data transport method that is part of the SAN Client feature.

The backup and restore traffic occurs over Fibre Channel, and the NetBackup server and client administration traffic occurs over the LAN.

For a NetBackup 52xx or 5330 appliance, Fibre Transport also provides high-speed traffic to a NetBackup 5000 series appliance that supports Fibre Transport. The traffic can be for duplication or for backups with the 5000 series appliance functioning as the storage host.

Figure 2-1 shows a SAN Client configuration.

Figure 2-1 A SAN Client configuration

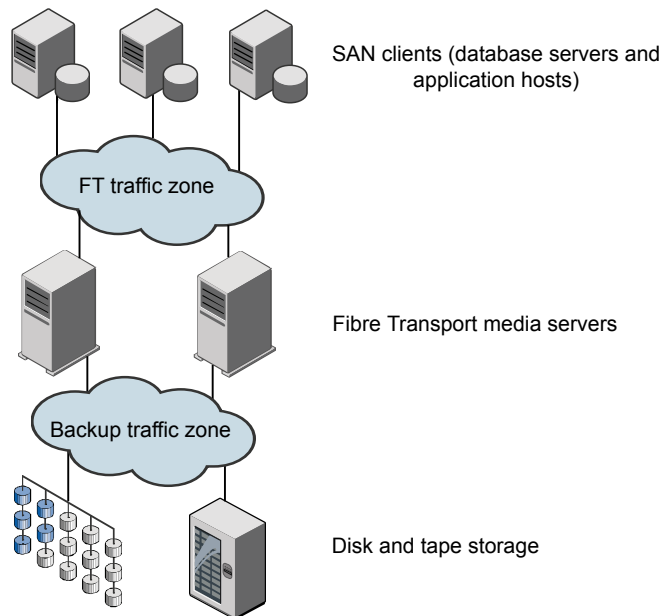

More information about configuring and using SAN Client is available.

See the *NetBackup SAN Client and Fibre Transport Guide*:

<http://www.symantec.com/docs/DOC5332>

See “[About the SAN Client license key](#)” on page 25.

See “[About zoning the SAN for NetBackup appliances](#)” on page 25.

See [“About Fibre Transport paths for NetBackup appliances”](#) on page 33.

About the SAN Client license key

Enter the SAN Client license key on the NetBackup master server.

If the NetBackup Enterprise Media Manager server runs on a host other than the master server, also enter the license key on that host.

If the license key expires or is unavailable (such as in a disaster recovery situation), backups and restores occur over the LAN.

About zoning the SAN for NetBackup appliances

Before you can configure and use the NetBackup Fibre Transport (FT) mechanism, the SAN must be configured and operational.

The NetBackup appliance supports the following SAN configurations:

- Node port (N_Port) switched configuration.
- Fibre Channel arbitrated loop (FC-AL) configuration.
FC-AL hubs are not supported.

For SAN switched configurations, proper zoning prevents Fibre Transport traffic from using the bandwidth that may be required for other SAN activity. Proper zoning also limits the devices that the host bus adapter (HBA) ports discover; the ports should detect the other ports in their zone only. Without zoning, each HBA port detects all HBA ports from all hosts on the SAN. The potentially large number of devices may exceed the number that the operating system supports.

Instructions for how to configure and manage a SAN are beyond the scope of the NetBackup documentation. However, the following recommendations may help you optimize your SAN traffic.

[Table 2-1](#) describes the best practices for zoning the SAN on NetBackup appliances.

Table 2-1 Best practices for zoning the SAN on NetBackup appliances

Guideline	Description
One initiator per zone, multiple targets acceptable.	<p>Symantec recommends that you create zones with only a single initiator per zone. Multiple targets in a single zone are acceptable, only if all of the targets are similar.</p> <p>Tape target resources should be in separate zones from disk target resources, regardless of initiator. However, both sets of resources may share the same initiator.</p>
Be aware of performance degradation when a port is configured for multiple zones.	If you use a single port as an initiator or a target for multiple zones, this port can become a bottleneck for the overall performance of the system. You must analyze the aggregate required throughput of any part of the system and optimize the traffic flow as necessary.
For fault tolerance, spread connectivity across HBA cards and not ports.	To ensure the availability of system connections, if you incorporate a multi-path approach to common resources, pair ports on separate cards for like zoning. This configuration helps you avoid the loss of all paths to a resource in the event of a card failure.
Zone the SAN based on WWN to facilitate zone migrations, if devices change ports.	It is recommended that you perform SAN zoning based on WWN. If switch port configurations or cabling architectures need to change, the zoning does not have to be recreated.

[Table 2-2](#) describes the zones you should use for your SAN traffic.

Diagrams that show the zones are available.

See [“About Fibre Transport paths for NetBackup appliances”](#) on page 33.

Note: You must use physical port ID or World Wide Port Name (WWPN) when you specify the HBA ports on NetBackup appliances.

See [“How to determine appliance HBA WWPNs”](#) on page 38.

Table 2-2 Appliance zones

Zone	Description
Fibre Transport backup zone	<p>A Fibre Transport backup zone should include only the Fibre Transport traffic between the SAN clients and the appliance.</p> <p>The backup zone should include the following HBA ports:</p> <ul style="list-style-type: none"> ■ The target port of the HBA—connect this port to a Fibre Channel switch port. If you have two HBAs, you can use both of them. The use of two ports provides redundancy. <p>Note: The supplied QLogic FC HBA card in a NetBackup appliance uses a special NetBackup target mode driver for the target port. The target mode driver replaces the default, initiator mode Fibre Channel driver. The target mode driver applies only to the supplied QLogic HBA card.</p> <p>You must define the appliance target port by physical port ID or World Wide Port Name (WWPN). The target mode driver WWPNs are not unique because they are derived from the Fibre Channel HBA WWPN.</p> <ul style="list-style-type: none"> ■ Ports on the SAN client HBAs that connect to the appliance—connect each SAN client HBA port to ports on the same Fibre Channel switch. <p>You can define SAN client ports by either port ID or WWPN. However, if you use one method for all devices, zone definition and management is easier.</p> <p>The ports on the SAN clients use the standard initiator mode driver.</p> <p>To promote multistream throughput, each SAN client should detect all target mode devices of the appliance HBA port or ports in the zone. Each appliance HBA target port exposes two target mode devices.</p> <ul style="list-style-type: none"> ■ Define the zones on the switch so that the client ports and the HBA target ports are in the same zone. <p>Some Symantec appliance models include one or more Fibre Channel HBACards that can be used for Fibre Transport. If your appliance does not include any of these cards, an authorized Symantec representative must install and configure an approved FC HBA.</p>

Table 2-2 Appliance zones (*continued*)

Zone	Description
Fibre Transport storage zone	<p>A Fibre Transport storage zone carries the Fibre Transport traffic from a NetBackup appliance to a NetBackup deduplication appliance. The traffic can be either for duplication or for backups. For backups, the data first travels to the NetBackup appliance and is then sent to the NetBackup deduplication appliance for storage.</p> <p>The storage zone should include the following HBA ports:</p> <ul style="list-style-type: none"> ■ The initiator port of the HBA in the NetBackup appliance—connect this port to a Fibre Channel switch port. It does not have to be the same switch as the backup zone. The NetBackup appliance is the source for the duplication. The initiator ports use the standard initiator mode driver. ■ The NetBackup deduplication appliance ports. For the 5020, connect the target ports (Port 1) of the HBAs in slots 1, 2, and / or 3 to the same Fibre Channel switch. For the 5030, connect the target ports (Port 1) of the HBAs in slots 2 or 5 to the same Fibre Channel switch. The 5020 or 5030 deduplication appliance is the target of the duplication jobs. <p>Note: To use Fibre Channel on a NetBackup 5020 or 5030, you must enable the Fibre Channel communication feature. For details, see the Symantec NetBackup Deduplication Appliance Software Administrator's Guide.</p> <ul style="list-style-type: none"> ■ Define the zones on the switch so that the NetBackup appliance initiator port and the NetBackup deduplication appliance target port are in the same zone. <p>Note: Only one initiator port and one target port can be configured for the same zone. Multiple initiator ports and target ports in the same zone are not supported.</p>
External tape storage zone	<p>If you use a tape library as storage, create a separate zone for that traffic. The tape storage zone does not use NetBackup Fibre Transport; it uses the standard initiator mode driver.</p> <p>The tape storage zone should include a port or ports on the FC HBA in slot 3 of a 52xx appliance, or on the FC HBA in slot 2 or 3 of a 5330 appliance.</p>

Settings > Network > Fibre Transport

The Fibre Transport (FT) options let you set up the appliance for FT use with SAN Clients or NetBackup deduplication appliances. By default, the FT options are disabled and the configuration of one option does not affect the other one.

The following describes the FT options:

Table 2-3 FT option descriptions

FT option	Description
<p>Enable SAN Client Fibre Transport on the Media Server (use FT for backups to this appliance)</p> <ul style="list-style-type: none"> ■ 2 target port Fibre Channel connection ■ 4 target port Fibre Channel connection 	<p>This option lets you change the port configuration of appliance Fibre Channel (FC) HBA cards for SAN Client FT use.</p> <p>The following describes the FC HBA cards that are affected:</p> <ul style="list-style-type: none"> ■ NetBackup 5220 - FC HBA cards in slots 2 and 4 ■ NetBackup 5230 and NetBackup 5330 - FC HBA cards in slots 5 and 6 <p>By default, the option is disabled and all ports are in the initiator mode.</p> <p>When the option is enabled and 2 target port Fibre Channel connection is selected, Port 1 on all affected FC HBA cards is set to the target mode. The appliance can now use these ports for deduplicated backups with the use of FT.</p> <p>When the option is enabled and 4 target port Fibre Channel connection is selected, Port 1 and Port 2 on all affected FC HBA cards are set to the target mode. The appliance can now use these ports for deduplicated backups with the use of FT.</p> <p>Before you enable this option, be aware of the following requirements and behavior:</p> <ul style="list-style-type: none"> ■ To use this option, a SAN Client license key must reside on the master server that is associated with this appliance. If FT is not currently used and you want to use the SAN Client feature, you must first obtain a SAN Client license key. To obtain the appropriate license key, contact Symantec Technical Support. Once you have the license key, you must add it to the master server. ■ When this option is enabled or changed, a warning appears to alert you that the appliance requires a restart. Before you enable this option, it is recommended that you first suspend or cancel all jobs.

Table 2-3 FT option descriptions (*continued*)

FT option	Description
Enable Fibre Transport for duplication and backups on a Deduplication Appliance	<p>This option lets you configure this appliance for use with a NetBackup 5020 or 5030 Deduplication Appliance. By default, this option is disabled and the appliance cannot communicate with a deduplication appliance.</p> <p>When the option is enabled, the appliance can use FT for duplication and backups to a deduplication appliance.</p> <p>When this option is enabled, you must also enable Fibre Channel communication on the associated or targeted NetBackup 5020 or 5030. For complete information, see the <i>Symantec NetBackup Deduplication Appliance Software Administrator's Guide</i>. Refer to the section "Verifying, enabling, or disabling Fibre Channel communication".</p>

Changing the Fibre Transport settings

Use the following procedure to change the Fibre Transport settings.

Before you change the Fibre Transport (FT) settings, read the following important information:

- When the FT SAN Client feature is enabled or changed, a message appears to alert you that the appliance requires a restart. Before you enable or change this feature, it is recommended that you first suspend or cancel all jobs.
- When the FT for duplication feature is enabled or changed, the deduplication storage daemons are restarted. Before you enable or change this feature, it is recommended that you first suspend or cancel all jobs.

To change the Fibre Transport settings

- 1 Log on to the NetBackup Appliance Web Console.
- 2 Click **Settings > Network**, then select **Fibre Transport**.
- 3 Click to enable the **Enable SAN Client Fibre Transport on the Media Server (use FT for backups to this appliance)**
- 4 To enable the SAN Client FT option, do one of the following:
 - 2 target port configuration
Click **Enable SAN Client Fibre Transport on the Media Server (use FT for backups to this appliance)** and select **2 target port Fibre Channel connection**. Then, click **Save**.

When the message appears to alert you that the appliance requires a restart, click **OK** to continue or click **Cancel** to prevent a restart. Clicking **Cancel** does not change the state of the feature.

- 4 target port configuration
Click **Enable SAN Client Fibre Transport on the Media Server (use FT for backups to this appliance)** and select **4 target port Fibre Channel connection**. Then, click **Save**.

When the message appears to alert you that the appliance requires a restart, click **OK** to continue or click **Cancel** to prevent a restart. Clicking **Cancel** does not change the state of the feature.

- 5 Click to enable the **Enable the Fibre Transport to a Deduplication appliance (for duplication or backups)**.

Note: To use this feature with a NetBackup Deduplication Appliance, you must also enable Fibre Channel communication on the associated NetBackup 5020 or 5030. For complete information, see the *Symantec NetBackup Deduplication Appliance Software Administrator's Guide*. Refer to the section "Verifying, enabling, or disabling Fibre Channel communication".

- 6 To enable FT for duplication and backups to a NetBackup 5020 or 5030, click **Enable the Fibre Transport to a Deduplication appliance (for duplication or backups)**. Then, click **Save**.

Note: To use this feature with a NetBackup Deduplication Appliance, you must also enable Fibre Channel communication on the associated NetBackup 5020 or 5030. For complete information, see the *Symantec NetBackup Deduplication Appliance Software Administrator's Guide*. Refer to the section "Verifying, enabling, or disabling Fibre Channel communication".

- 7 Click **Save** to apply the changed settings.
- 8 To disable either one of the FT options, click the option to clear the check mark. Then, click **Save**.

- 9 To disable either one of the FT options, deselect the option to clear the check mark. Then, click **Save**.

If you selected to disable the FT SAN Client feature, an alert appears to inform you that the appliance requires a restart. Click **OK** to continue or click **Cancel** to prevent a restart. Clicking **Cancel** does not change the state of the feature.

If you selected to disable the FT for duplication feature, an alert appears to inform you that the deduplication storage daemons require a restart. Click **OK** to continue or click **Cancel** to prevent a restart. Clicking **Cancel** does not change the state of the feature.

- 10 After the appliance has been restarted, verify the FT settings that you selected as follows:
 - Log on to the NetBackup Appliance Web Console.
 - Click **Settings > Network**, then select **Fibre Transport**.
 - Verify that the settings are correct.

See [“Settings > Network > Fibre Transport”](#) on page 28.

See [“About Fibre Channel port configuration options for the NetBackup 52xx appliances”](#) on page 11.

Guidelines for changing NetBackup appliance FT target ports to receive data streams from multiple SAN Client FC initiator ports

If you want an appliance Fibre Transport (FT) target port to handle data streams from more than two SAN client Fibre Channel (FC) initiator ports concurrently, consider changing the following NetBackup master server setting:

```
nbftconfig -setconfig -ncp 4
```

Caution: This setting applies to all target ports on all FT media servers in your NetBackup domain. This setting should only be increased from the default (2) when all of the following conditions exist:

All FT target ports on all FT media servers are eight gBit/s link speeds.

The total mix of FT jobs is such that all of the FT media servers have unused FT pipes.

A large number of jobs from other SAN Client machines are waiting for resources.

The back-end storage units have a lot of unused throughput capacity.

If you increase the `-ncp` setting too high, the load balancing between multiple FT media servers when all SAN Client machines are zoned to all FT media servers could become highly imbalanced.

Note: A mix of SAN Client job loads where some clients use four or more FT pipes concurrently with several other SAN Clients that only attempt to use a single FT pipe at a time increases the odds that a higher `-ncp` setting may cause FT media server imbalance.

For four gBit/s links, there may be situations where overall throughput can degrade when some or all SAN Clients are using multiple concurrent data streams. This scenario may be especially true for NetBackup 5220 appliances. In those situations, `nbftconfig -setconfig -ncp 3` may be a better option.

About Fibre Transport paths for NetBackup appliances

[Table 2-4](#) shows the backup, restore, and duplication paths for NetBackup Fibre Transport for NetBackup appliances. It also shows the user interface Fibre Transport settings in the NetBackup Appliance Web Console that enable the functionality.

See [“Changing the Fibre Transport settings”](#) on page 30.

Fibre Transport requires the following appliance software versions:

- NetBackup 5330 appliance versions 2.6.1 and later are compatible with NetBackup 50xx deduplication appliance versions 1.4.2 and later.

Table 2-4 Appliance Fibre Transport targets

Function	From	To	Fibre Transport settings that activate the functionality
Backups	NetBackup SAN client.	NetBackup 52xx or 5330 appliance. The appliance is the backup server and the storage host.	Enable the SAN Client FT media server (Fibre Transport for backups to this appliance)
Restores	NetBackup 52xx or 5330 appliance. The appliance is the restore server and the storage host.	NetBackup SAN client.	Enable the SAN Client FT media server (Fibre Transport for backups to this appliance)
Backups	NetBackup SAN client.	NetBackup 5020 deduplication appliance. The 5020 deduplication appliance is the storage host. The 52xx or 5330 appliance is the backup server and forwards the backups to the 5020 appliance.	Enable the SAN Client FT media server (Fibre Transport for backups to this appliance) Enable the Fibre Transport to a Deduplication appliance (for duplication or for backups)
Restores	NetBackup 5020 appliance. The 5020 deduplication appliance is the storage host. It sends the restore traffic through the 52xx or 5330 appliance, which is the restore server.	NetBackup SAN Client.	Enable the SAN Client FT media server (Fibre Transport for backups to this appliance) Enable the Fibre Transport to a Deduplication appliance (for duplication or for backups)
Duplication	NetBackup 52xx or 5330 appliance.	NetBackup 5020 deduplication appliance.	Enable the Fibre Transport to a Deduplication appliance (for duplication or for backups)

An external tape library uses the standard initiator mode driver over Fibre Channel, not NetBackup Fibre Transport. Therefore, if you duplicate backup images from a tape library to a NetBackup 5020 deduplication appliance, traffic occurs as follows:

- Fibre Channel between the tape library and the 52xx or 5330 appliance.
- Fibre Transport between the 52xx or 5330 appliance and the 50xx deduplication appliance.

Figure 2-2 shows the duplication paths from a 5220 appliance to a 5020 deduplication appliance.

Figure 2-2 Appliance deduplication paths

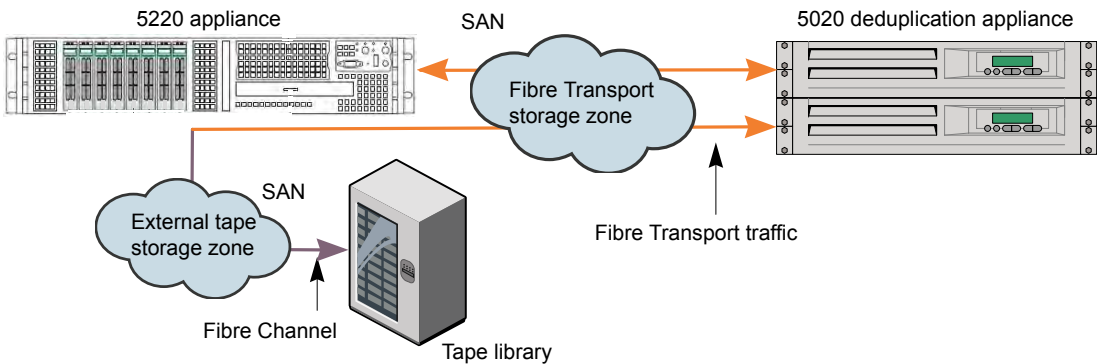

The following items describe the path in [Figure 2-2](#):

- Duplication from the 52xx or 5330 appliance to the 50xx deduplication appliance. If the duplication source is deduplicated storage on the 52xx or 5330 appliance, the operation is optimized duplication. If the duplication source is AdvancedDisk storage, the operation is normal duplication.
- Duplication from the 50xx deduplication appliance to the 52xx or 5330 appliance. The operation is normal duplication.
- Duplication from the tape storage over Fibre Channel to the 52xx or 5330 appliance and then over Fibre Transport to the 50xx deduplication appliance. The operation is normal duplication.
- Duplication from the 50xx deduplication appliance over Fibre Transport to the 52xx or 5330 appliance and then over Fibre Channel to the tape storage. The operation is normal duplication.

For duplication, you must configure the 50xx deduplication appliance as a storage server in NetBackup. Then, use either a storage lifecycle policy or the NetBackup Catalog utility to duplicate backup images.

The following describes the resiliency available for Fibre Transport jobs:

- Multiple Fibre Transport paths can exist between hosts.
- Back up, restore, and duplication jobs failover to other Fibre Transport paths if they exist. If no other FT paths are available, jobs fail.
- Optimized duplication jobs failover to other Fibre Transport paths if they exist. If no other FT paths are available, they fail over to the Ethernet network. If no FT connection or IP connection exists, optimized duplication jobs fail.

- If no Fibre Transport connections exist, NetBackup uses an IP connection for new jobs.

Figure 2-3 shows the possible backup and restore paths for a NetBackup SAN client.

Figure 2-3 SAN client backup and restore paths

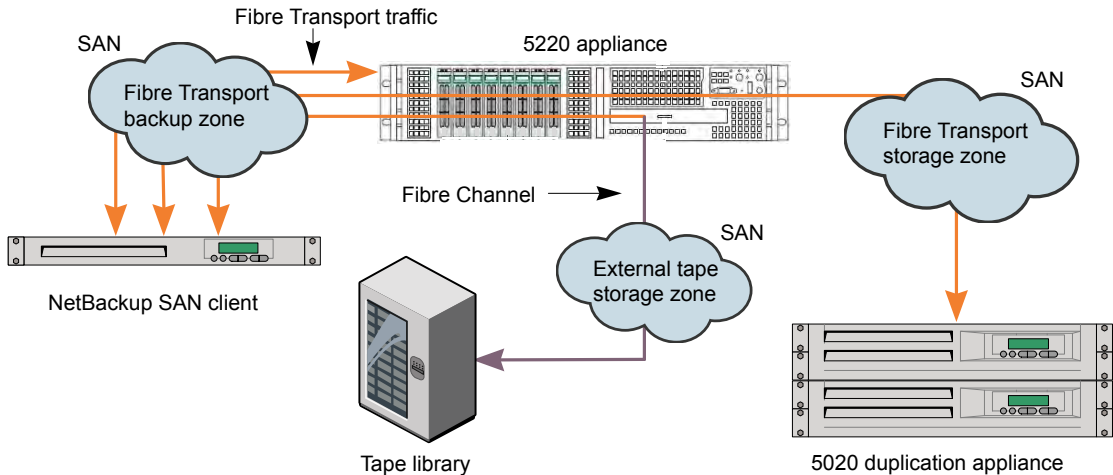

The following items describe the paths in Figure 2-3:

- Fibre Transport between the client and the 52xx or 5330 appliance. The backups reside on disk storage on the appliance. You can use Fibre Transport both for backups to deduplication storage and backups to AdvancedDisk storage.
- Fibre Transport between the client and the 50xx deduplication appliance through the 52xx or 5330 appliance. The traffic travels through two different SAN zones. The backups are deduplicated and reside on disk storage on the 50xx deduplication appliance.
- Fibre Transport between the client and a 52xx or 5330 appliance, and then Fibre Channel between the appliance and the tape library. The traffic travels through two different SAN zones. The backups are not deduplicated.

Table 2-5 shows the port configurations for SAN Client, optimized duplication (storage zone), and tape applications as described in Figure 2-3.

Table 2-5 Port configurations for SAN Client backup and restore paths

5220 FC HBA slot location	5230 FC HBA slot location	5330 FC HBA slot location	Port 1 usage	Port 2 usage
Slot 2	Slot 5	Slot 5	SAN Client	Optimized duplication (storage zone)
Slot 3	Slot 2 or 3	Slot 2 or 3	Tape	Tape
Slot 4	Slot 6	Slot 6	SAN Client	Optimized duplication (storage zone)

Figure 2-4 shows the possible backup and restore paths for a NetBackup client over a LAN.

Figure 2-4 LAN client backup and restore paths

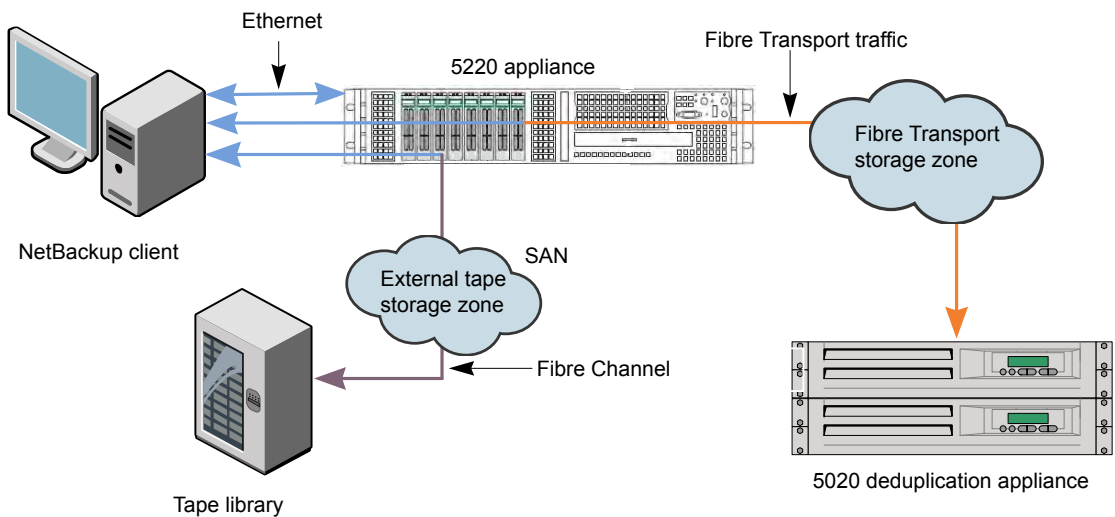

The following items describe the paths in Figure 2-4:

- Ethernet between the client and the 52xx or 5330 appliance. The backups reside on either deduplicated storage or AdvancedDisk storage on the appliance.
- Ethernet between the client and the 52xx or 5330 appliance, and then Fibre Transport between the 52xx or 5330 appliance and the 50xx deduplication appliance. The backups are deduplicated and reside on disk storage on the 50xx appliance.

- Ethernet between the client and the 52xx or 5330 appliance, and then Fibre Channel between the appliance and the tape library. The backups are not deduplicated.

Table 2-6 shows the port configurations for optimized duplication (storage zone) and tape applications as described in Figure 2-4

Table 2-6 Port configurations for optimized duplication (storage zone) and tape applications

5220 FC HBA slot location	5230 FC HBA slot location	5330 FC HBA slot location	Port 1 usage	Port 2 usage
Slot 2	Slot 5	Slot 5	NA	Optimized duplication (storage zone)
Slot 3	Slot 2 or 3	Slot 2 or 3	Tape	Tape
Slot 4	Slot 6	Slot 6	NA	Optimized duplication (storage zone)

How to determine appliance HBA WWPNS

You must use physical port ID or World Wide Port Name (WWPN) when you specify the HBA ports on NetBackup appliances.

To determine the WWPNS, use the `FC Show` command in the NetBackup Appliance Shell Menu. The command output provides the information about ports based on the slot number.

For complete information about the NetBackup Appliance Shell Menu, see the *Symantec NetBackup 52xx Series Command Reference Guide*.

Table 2-7 describes the supported FC HBA slots and their purposes for the 5020 appliance.

Table 2-7 5020 appliance FC HBA slots

FC HBA purpose	NetBackup 5020
NetBackup Fibre Transport traffic	<p>For cards in slots 1 or 3:</p> <ul style="list-style-type: none"> ■ In <code>FC Show</code> output, the top port (Port 1) Mode is <code>Target</code> when configured properly. ■ In <code>FC Show</code> output, the bottom port (Port 2) Mode is <code>Initiator</code>.

How to configure two NetBackup 52xx or 5330 appliances in different domains for MSDP replication

This topic describes how to establish the replication relationship between a NetBackup 52xx or 5330 appliance in an originating domain and a NetBackup 52xx or 5330 appliance in a target domain. The process is very similar to traditional (non-appliance) NetBackup environments that use Media Server Deduplication Pool (MSDP) replication in different domains.

Successful configuration requires that you perform other tasks that are documented in the *Symantec NetBackup 7.5 Deduplication Guide*.

The following table describes the steps to configure two NetBackup 52xx or 5330 appliances in different domains for MSDP replication. References to other tasks are also included.

Table 2-8 Steps to configure two NetBackup 52xx appliances in different domains for MSDP replication

Step	Task description
1	On one of the NetBackup 52xx or 5330 appliances, log in to the NetBackup Appliance Shell Menu.
2	Obtain the NetBackup deduplication password of the domain by running the following command: <pre>Main > Appliance > ShowDedupePassword</pre> Record this password for later use in Step 4.
3	On the local NetBackup master server, log in and start the NetBackup Administration Console.
4	Add the NetBackup 52xx or 5330 as a replication target by using the root user and the password that you recorded in Step 2. For complete details, see the <i>Symantec NetBackup 7.5 Deduplication Guide</i> . Refer to the following topic in the chapter titled Configuring deduplication : "Configuring a target for MSDP replication".

Table 2-8 Steps to configure two NetBackup 52xx appliances in different domains for MSDP replication (*continued*)

Step	Task description
5	<p>On the primary side, do the following:</p> <ul style="list-style-type: none"> ■ Using the MSDP storage unit on the primary NetBackup 52xx or 5330 that is used for backups, create a storage lifecycle policy (SLP). For complete details, see the <i>Symantec NetBackup 7.5 Deduplication Guide</i>. Refer to the following topic in the chapter titled Configuring deduplication: "Creating a storage lifecycle policy". ■ Create a Duplication storage operation for this SLP, using the remote NetBackup 52xx or 5330 appliance as the destination. For complete details, see the <i>Symantec NetBackup 7.5 Deduplication Guide</i>. Refer to the following topic in the chapter titled Configuring deduplication: "Adding a storage operation to a storage lifecycle policy".
6	<p>On the remote side, do the following:</p> <ul style="list-style-type: none"> ■ Create an SLP with the exact same name as the one that was created for the primary side. ■ Create an Import storage operation for this SLP, using the MSDP on the remote NetBackup 52xx or 5330 appliance as the destination.

Configuring direct backups from a NetBackup 52xx or 5330 appliance to a NetBackup 50xx appliance using Fibre Channel

This topic describes how to configure a NetBackup 52xx or 5330 media server to send all backups directly to a NetBackup 5020 or 5030 deduplication appliance.

The target and the initiator configuration for the appliances must be set as follows:

- NetBackup 5020 or 5030
This appliance is set up as the disk pool (target). Any available target port on a Fibre Channel HBA card can be used.
- NetBackup 52xx or 5330
This appliance is set up as the backup image source (initiator). Any available initiator port on a Fibre Channel HBA card can be used.

Use the following procedure to configure direct backups from a NetBackup 52xx or 5330 appliance to a NetBackup 50xx using Fibre Channel.

To configure direct backups from a NetBackup 52xx or 5330 appliance to a NetBackup 50xx appliance using Fibre Channel

- 1 On the NetBackup 50xx, enable Fibre Channel communication as follows:

Note: If Fibre Channel communication is already enabled on this appliance, skip this step.

From the NetBackup Appliance Shell Menu:

- Use a Secure Shell (SSH) agent to connect to the 5020 deduplication appliance for which you want to enable Fibre Channel communication. For example, you can use **PuTTY**, which is available as a free download.
- Log into the deduplication appliance. By default, the user name is `sysadmin`, and the password is `P@ssw0rd`. In the preceding password, the sixth character is the numeral zero (0).
- At the system prompt, type `FC` and press **Enter**.
- To display the Fibre Channel connections that are currently in effect, type `show nodeip`. For `nodeip`, type the IP address of the 5020 deduplication appliance for which you want to enable Fibre Channel communication.
- To enable Fibre Channel communication for this appliance, type `enable-ft`.

From the NetBackup Appliance Web Console:

- Open a browser, and type the following URL to access the storage pool authority's opening panel:
`https://URL`
For `URL`, type the URL for the storage pool authority node.
- Log in as `root`.
- Click **Settings > Configuration**.
- In the left pane, under **Configuration**, click **Fibre Transport**.
- In the right pane, under the **Fibre Transport** heading, click in the box and click **Save**.

- 2 Set up the zones for the 50xx Fibre Channel ports to configure the 50xx as the target storage server.

- 3 Connect an available target port from any Fibre Channel card on the 50xx, to an available initiator port on any Fibre Channel card on the NetBackup 52xx or 5330.

See [“Supported PCIe card and Fibre Channel options for the NetBackup 5330 appliance”](#) on page 18.

See [“About Fibre Channel port configuration options for the NetBackup 52xx appliances”](#) on page 11.

VMware support

This chapter includes the following topics:

- [About the NetBackup appliance as a VMware backup host](#)
- [About appliance dynamic multipathing for VMware backups with SAN transport](#)

About the NetBackup appliance as a VMware backup host

The NetBackup appliance can back up virtual machines without a separate Windows system as backup host.

Note: You must use the VMware policy type.

To convert policies to the VMware type, you can use the `nbplupgrade` command. For details, see the *NetBackup Commands Reference Guide*.

The following topics contain notes on the appliance as the backup host:

- For an overview of the appliance as backup host in a virtual environment: See "[Appliance as backup host: component overview](#)" on page 44.
- For a list of requirements and limitations: See "[Notes on the NetBackup appliance as a VMware backup host](#)" on page 44.
- For further information, see the latest *NetBackup for VMware Administrator's Guide*:
<http://www.symantec.com/docs/DOC5332>

Appliance as backup host: component overview

As [Figure 3-1](#) shows, the appliance can operate as the VMware backup host. A separate Windows backup host is not required.

The appliance as backup host can also run the NetBackup media server and master server.

Figure 3-1 NetBackup for VMware with appliance as backup host

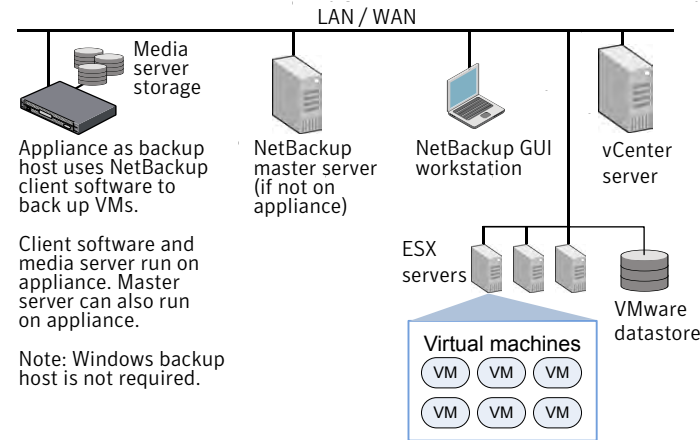

NetBackup appliances support dynamic multi-pathing (DMP) in a SAN environment:

See [“About appliance dynamic multipathing for VMware backups with SAN transport”](#) on page 45.

Further information is available on the appliance as backup host:

See [“Notes on the NetBackup appliance as a VMware backup host”](#) on page 44.

Notes on the NetBackup appliance as a VMware backup host

Note the following requirements and limitations for the appliance as the backup host:

- The appliance must be version 2.5 or later. If the master server is on a separate host (not on the backup host), the master server must use NetBackup 7.5.0.1 or later.
- On the host that runs the NetBackup Administration Console or the Backup, Archive, and Restore interface, NetBackup must be at 7.5.0.1 or later.
- You must use the VMware policy type.

- The appliance does not support iSCSI connections. References to iSCSI in this guide do not apply to the appliance.

About appliance dynamic multipathing for VMware backups with SAN transport

NetBackup appliances support dynamic multi-pathing (DMP) in a SAN environment for VMware backups. DMP enhances I/O performance by distributing requests across all available paths. DMP on the Appliance can distinguish between the active paths and passive paths and make use of the active paths.

In a failover scenario, inputs and outputs are rerouted to healthy data paths. The failed paths are restored automatically when they become healthy. DMP also reduces the complexity of managing thousands of I/O paths in case they need to be temporarily disabled for array maintenance.

Figure 3-2 NetBackup appliance components for DMP on SAN

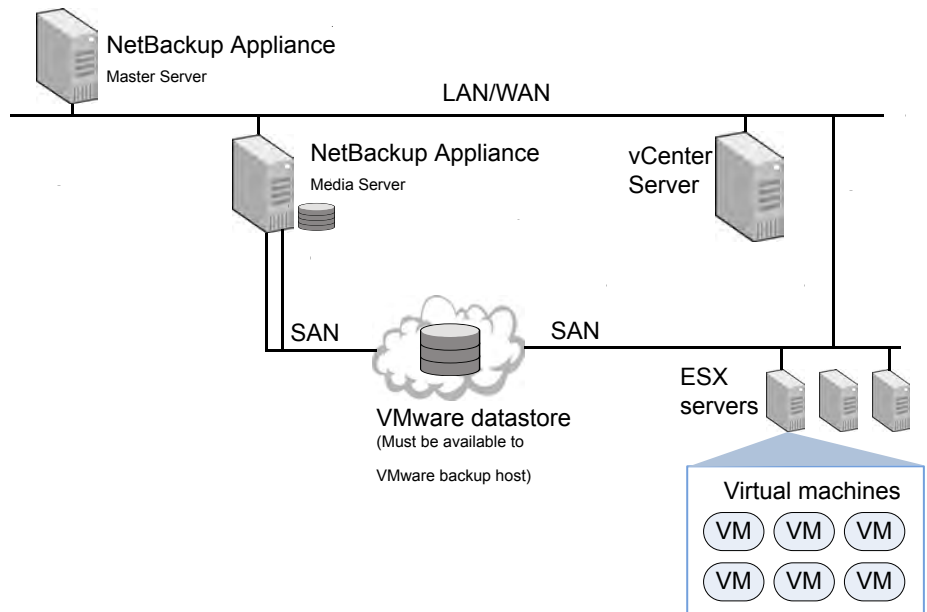

For more information on whether this function is supported by your system, see the Disk Arrays > Linux section in the *Hardware Compatibility List* at the following link: <http://www.symantec.com/docs/TECH170013>

See “Notes on the NetBackup appliance as a VMware backup host” on page 44.

Index

A

- about
 - backup to tape support for appliances 22
 - Fibre Channel port configuration options 11
- appliance FT target ports
 - guidelines for multiple SAN Client FC initiator ports 32
- appliance support
 - for backup to tape 22

B

- backup to tape
 - appliance support for 22

C

- change FT settings 30
- configure direct backups using FC
 - from a NetBackup 52xx to a NetBackup 50xx 40
- configure MSDP replication
 - for two 52xx or 5330 appliances in different domains 39

D

- direct backups from a NetBackup 52xx to a NetBackup 50xx
 - configuring 40

F

- Fibre Channel
 - port configuration options 11
- Fibre Transport
 - option descriptions 28
- FT settings
 - change 30

G

- guidelines for changing appliance FT target ports
 - for multiple SAN Client FC initiator ports 32

H

- HBA WWPN
 - how to determine for appliance 38

N

- NetBackup 5330
 - supported PCIe card and Fibre Channel options 18

O

- option descriptions
 - for Fibre Transport 28

P

- port configuration options
 - for Fibre Channel 11

S

- supported data transfer methods
 - for NetBackup appliances 9
- supported PCIe card and Fibre Channel options
 - for NetBackup 5330 18

T

- two 52xx appliances in different domains
 - configure for MSDP replication 39