

# Veritas NetBackup™ 5330 Appliance Product Description

Release 2.7.2

**VERITAS™**

# Veritas NetBackup™ 5330 Appliance Product Description

Documentation version: 2.7.2

## Legal Notice

Copyright © 2016 Veritas Technologies LLC. All rights reserved.

Veritas and the Veritas Logo are trademarks or registered trademarks of Veritas Technologies LLC or its affiliates in the U.S. and other countries. Other names may be trademarks of their respective owners.

This product may contain third party software for which Veritas is required to provide attribution to the third party ("Third Party Programs"). Some of the Third Party Programs are available under open source or free software licenses. The License Agreement accompanying the Software does not alter any rights or obligations you may have under those open source or free software licenses. Please see the Third Party Legal Notice Appendix to this Documentation or TPIP ReadMe File accompanying this product for more information on the Third Party Programs.

The product described in this document is distributed under licenses restricting its use, copying, distribution, and decompilation/reverse engineering. No part of this document may be reproduced in any form by any means without prior written authorization of Veritas Technologies LLC and its licensors, if any.

THE DOCUMENTATION IS PROVIDED "AS IS" AND ALL EXPRESS OR IMPLIED CONDITIONS, REPRESENTATIONS AND WARRANTIES, INCLUDING ANY IMPLIED WARRANTY OF MERCHANTABILITY, FITNESS FOR A PARTICULAR PURPOSE OR NON-INFRINGEMENT, ARE DISCLAIMED, EXCEPT TO THE EXTENT THAT SUCH DISCLAIMERS ARE HELD TO BE LEGALLY INVALID. VERITAS TECHNOLOGIES LLC SHALL NOT BE LIABLE FOR INCIDENTAL OR CONSEQUENTIAL DAMAGES IN CONNECTION WITH THE FURNISHING, PERFORMANCE, OR USE OF THIS DOCUMENTATION. THE INFORMATION CONTAINED IN THIS DOCUMENTATION IS SUBJECT TO CHANGE WITHOUT NOTICE.

The Licensed Software and Documentation are deemed to be commercial computer software as defined in FAR 12.212 and subject to restricted rights as defined in FAR Section 52.227-19 "Commercial Computer Software - Restricted Rights" and DFARS 227.7202, et seq. "Commercial Computer Software and Commercial Computer Software Documentation," as applicable, and any successor regulations, whether delivered by Veritas as on premises or hosted services. Any use, modification, reproduction release, performance, display or disclosure of the Licensed Software and Documentation by the U.S. Government shall be solely in accordance with the terms of this Agreement.

Veritas Technologies LLC  
500 E Middlefield Road  
Mountain View, CA 94043

<http://www.veritas.com>

# Technical Support

Technical Support maintains support centers globally. Technical Support's primary role is to respond to specific queries about product features and functionality. The Technical Support group also creates content for our online Knowledge Base. The Technical Support group works collaboratively with the other functional areas within the company to answer your questions in a timely fashion.

Our support offerings include the following:

- A range of support options that give you the flexibility to select the right amount of service for any size organization
- Telephone and/or Web-based support that provides rapid response and up-to-the-minute information
- Upgrade assurance that delivers software upgrades
- Global support purchased on a regional business hours or 24 hours a day, 7 days a week basis
- Premium service offerings that include Account Management Services

For information about our support offerings, you can visit our website at the following URL:

[www.veritas.com/support](http://www.veritas.com/support)

All support services will be delivered in accordance with your support agreement and the then-current enterprise technical support policy.

## Contacting Technical Support

Customers with a current support agreement may access Technical Support information at the following URL:

[www.veritas.com/support](http://www.veritas.com/support)

Before contacting Technical Support, make sure you have satisfied the system requirements that are listed in your product documentation. Also, you should be at the computer on which the problem occurred, in case it is necessary to replicate the problem.

When you contact Technical Support, please have the following information available:

- Product release level
- Hardware information
- Available memory, disk space, and NIC information

- Operating system
- Version and patch level
- Network topology
- Router, gateway, and IP address information
- Problem description:
  - Error messages and log files
  - Troubleshooting that was performed before contacting Technical Support
  - Recent software configuration changes and network changes

## Licensing and registration

If your product requires registration or a license key, access our technical support Web page at the following URL:

[www.veritas.com/support](http://www.veritas.com/support)

## Customer service

Customer service information is available at the following URL:

[www.veritas.com/support](http://www.veritas.com/support)

Customer Service is available to assist with non-technical questions, such as the following types of issues:

- Questions regarding product licensing or serialization
- Product registration updates, such as address or name changes
- General product information (features, language availability, local dealers)
- Latest information about product updates and upgrades
- Information about upgrade assurance and support contracts
- Advice about technical support options
- Nontechnical presales questions
- Issues that are related to CD-ROMs, DVDs, or manuals

## Support agreement resources

If you want to contact us regarding an existing support agreement, please contact the support agreement administration team for your region as follows:

Worldwide (except Japan)

[CustomerCare@veritas.com](mailto:CustomerCare@veritas.com)

Japan

[CustomerCare\\_Japan@veritas.com](mailto:CustomerCare_Japan@veritas.com)

# Contents

Technical Support .....	4	
<b>Chapter 1</b>	<b>NetBackup 5330 Appliance overview .....</b>	<b>9</b>
	About the NetBackup 5330 Appliance .....	9
	NetBackup 5330 compute node disk configurations .....	12
	NetBackup 5330 Appliance compute node control panel information .....	14
	About the NetBackup 5330 Appliance compute node rear panel .....	15
	About NetBackup 5330 Appliance compute node PCIe slot configurations .....	17
	NetBackup 5330 compute node Ethernet port configurations .....	18
	Dual-port 8 Gb Fibre Channel Host Bus Adapter (FC HBA) specifications .....	19
	Dual-port 10 Gb Ethernet card specifications .....	19
	About NetBackup 5330 Appliance storage shelves .....	20
	Available appliance storage capacities .....	20
	About the NetBackup 5330 Appliance Primary Storage Shelf and Expansion Storage Shelf front panel .....	22
	About the NetBackup 5330 Appliance Primary Storage Shelf and Expansion Storage Shelf rear panels .....	24
	Best practices for rack installation .....	30
<b>Chapter 2</b>	<b>NetBackup 5330 Appliance cables .....</b>	<b>32</b>
	Power cables .....	32
	Network cable .....	33
	Multi-Mode fibre cable .....	34
	SAS cable .....	35
<b>Appendix A</b>	<b>Technical specifications, standards, and     compliance information .....</b>	<b>36</b>
	NetBackup 5330 Appliance system technical specifications .....	36
	Environmental specifications .....	39
	Protocol standards .....	40

Regulatory, compliance, and certification information .....	40
Index .....	41



# NetBackup 5330 Appliance overview

This chapter includes the following topics:

- [About the NetBackup 5330 Appliance](#)
- [About NetBackup 5330 Appliance storage shelves](#)
- [Best practices for rack installation](#)

## About the NetBackup 5330 Appliance

The NetBackup 5330 Appliance is a hardware and software storage system that scales to a total of 456TB of usable backup capacity. It consists of a 2U NetBackup 5330 Appliance compute node and one externally attached 4U Primary Storage Shelf. You can add up to two optional 4U Expansion Storage Shelves if you require additional storage.

Fibre channel (FC) cables connect the NetBackup 5330 Appliance compute node to the Primary Storage Shelf. SAS cables connect the Primary Storage Shelf to the Expansion Storage Shelf.

## NetBackup 5330 Appliance system features

**Table 1-1** NetBackup 5330 Appliance system features

Feature	Description
Performance and capacity	<ul style="list-style-type: none"> <li>■ Processor - two Intel Xeon 10-core 3.0 GHz E5-2690 v2 CPUs.</li> <li>■ Supports the high-performance processors with low-power consumption.</li> <li>■ Provides high-capacity intra-appliance switching bandwidth, along with high I/O throughput.</li> <li>■ Usable capacity can be any combination of up to 229.2 TB. The usable capacity can be allocated either in part or in whole to a deduplication pool or to an Advanced Disk pool (non-deduplicated storage).</li> </ul>
System memory configuration (DIMMs)	16 GB x 24; total RAM: 384 GB
RAID cache	24 GB
Space reduction	The deduplication engine provides up to 100 times reduction in storage. The client-side plug-in provides similar levels of bandwidth reduction.
Scalable architecture	<p>Due to fingerprinting and RAID redundancy, the overall storage capabilities are not a simple multiplication of the disk size and the total number of disks.</p> <p>The NetBackup 5330 Appliance storage system can be configured with a required Primary Storage Shelf, or a Primary Storage Shelf with one or more optional Expansion Storage Shelves. A NetBackup 5330 Appliance compute node that is paired with a Primary Storage Shelf provides usable storage capacity of 229 TB. When the compute node is paired with both the Primary Storage Shelf and the optional Expansion Storage Shelves, usable storage capacity increases to 456 TB.</p>
High availability	Supports redundant hot-swappable disks and power modules.

**Table 1-1** NetBackup 5330 Appliance system features (*continued*)

Feature	Description
Easy management	<p>Provides separate out-of-band management network interfaces. You can remotely turn on, turn off, and reset appliances through the network.</p> <p>Supports the SNMP traps and automatically reports alarms.</p> <p>Supports reporting the disk information through the out-of-band management channel.</p>
RAID levels	<p>RAID1 (striping and mirroring) and RAID6 (block level striping with double distributed parity) are used as follows:</p> <ul style="list-style-type: none"> <li>■ NetBackup 5330 compute node system disks: RAID1</li> <li>■ Storage shelf data storage disks: RAID6</li> </ul>
Fibre Channel support	<p>The NetBackup 5330 compute node can be ordered with two, three, five, or six Fibre Channel (FC) HBA cards already installed. Each card includes two standard Fibre Channel ports. If less than six FC HBA cards are ordered, a 10 Gb Ethernet card with two standard ports can be ordered. The compute node uses the QLE2562, a QLogic 8 Gb FC PCIe dual port adapter.</p>
Rear panel ports	<p>One 1 Gb/s IPMI remote network port</p> <p>One VGA port</p> <p>Four 1 GE network ports, with an RJ-45 connector, and link and activity LEDs. Two of the ports are reserved for private networks.</p> <p>Two 10 GE network ports, with Small Form-factor Pluggable (SFP) modules, and link and activity LEDs.</p>

See [“NetBackup 5330 compute node disk configurations”](#) on page 12.

See [“NetBackup 5330 Appliance compute node disk drive LED descriptions”](#) on page 13.

See [“NetBackup 5330 Appliance compute node control panel information”](#) on page 14.

See [“About the NetBackup 5330 Appliance compute node rear panel”](#) on page 15.

See [“About NetBackup 5330 Appliance compute node PCIe slot configurations”](#) on page 17.

See [“NetBackup 5330 compute node Ethernet port configurations”](#) on page 18.

See “Dual-port 8 Gb Fibre Channel Host Bus Adapter (FC HBA) specifications” on page 19.

See “Dual-port 10 Gb Ethernet card specifications” on page 19.

## NetBackup 5330 compute node disk configurations

The NetBackup 5330 compute node contains eight 3TB SAS disks, which can be accessed from the compute node's front panel. An embedded RAID controller on the compute node's mainboard is used to configure four of the eight disks into two RAID1 mirrored volumes. These volumes are labeled Volume 0 and Volume 1. The disks that are located in slot 0 and slot 1 are configured as the RAID1, VOLUME 0 device, while the disks in slot 3 and slot 4 are configured as the RAID1, VOLUME 1 device. VOLUME 0 contains the NetBackup 5330 compute node operating system and the NetBackup application.

The disks in slots 3 and 4 are configured as the RAID 1, VOLUME 1 device.

The appliance uses the disks that are located in slot 2 and slot 5 as hot-spare disks. If a disk in either RAID volume experiences a hardware error, the appliance automatically initiates a RAID rebuild operation. During the rebuild operation, the appliance randomly selects a hot-spare disk from slot 2 or slot 5, and then rebuilds the RAID volume.

The disks in slots 6 and 7 are reserved for future use.

See [Figure 1-1](#) on page 12.

**Figure 1-1** NetBackup 5330 Appliance compute node front panel disk slot assignments



**Table 1-2** NetBackup 5330 Appliance compute node disk slot assignments and RAID disk assignments

NetBackup 5330 Appliance compute node disk slot assignments and RAID disk assignments								
Slots	0	1	2	3	4	5	6	7

**Table 1-2** NetBackup 5330 Appliance compute node disk slot assignments and RAID disk assignments (*continued*)

NetBackup 5330 Appliance compute node disk slot assignments and RAID disk assignments								
RAID layout	Disk0 of RAID1, Volume 0	Disk1 of RAID1, Volume 0	Hot spare disk	Disk0 of RAID1, Volume 1	Disk1 of RAID1, Volume 1	Hot spare disk	Reserved for future use	Reserved for future use
	Set as Boot Volume		Slots 8, 9, 10, and 11 are intentionally empty for compute node cooling purposes.					

## NetBackup 5330 Appliance compute node disk drive LED descriptions

Each disk drive module contains two LEDs on the left-hand side of each module.

The LEDs appear as follows:

- The LED on the top is solid amber when a disk drive fault occurs. This LED is not lit when there are no disk drive faults.
- The LED on the bottom is solid green when power is supplied to the disk drive. This LED flashes green when the disk drive is active.

Note that the disk drive modules that do not contain disk drives also have LEDs. Although there is no drive activity going on, some colored lights may still be seen through the disk modules.

**Figure 1-2** Disk drive module LEDs



**Table 1-3** Disk drive module LED descriptions

LED color	Condition	Description/Behavior
Amber	Off	No access and no fault
Amber	Solid On	A hard drive fault has occurred
Amber	Blinking	A RAID rebuild is in progress (1 Hz), Identify (2 Hz)

**Table 1-3** Disk drive module LED descriptions (*continued*)

LED color	Condition	Description/Behavior
Green	Power on with no drive activity	LED stays on
Green	Power on with drive activity	LED blinks off when processing a command
Green	Power on and drive spun down	LED stays off
Green	Power on and drive spinning up	LED blinks

## NetBackup 5330 Appliance compute node control panel information

The front panel of the NetBackup 5330 Appliance compute node includes a small panel that is attached to the right side of the device. System information is shown on this panel.

**Figure 1-3** NetBackup 5330 Appliance compute node control panel

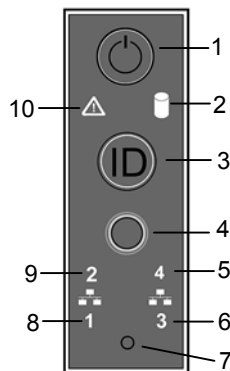

**Table 1-4** LED panel descriptions

Label	Description
1	AC power button with integrated LED (executes a shutdown before turning off power)
2	Hard drive activity LED
3	ID button with integrated LED

**Table 1-4** LED panel descriptions (*continued*)

Label	Description
4	Cold reset button (restarts the appliance instantly)
5	NIC4/eth3 activity LED (for public use)
6	NIC3/eth2 activity LED (for public use)
7	NMI button (recessed; a tool is required for use)
8	NIC1/eth0 activity LED (for public use)
9	NIC2/eth1 activity LED (for public use)
10	Status LED

## About the NetBackup 5330 Appliance compute node rear panel

The rear panel of a NetBackup 5330 Appliance compute node has several access ports and other features, which are displayed in the following diagram and table.

**Figure 1-4** NetBackup 5330 Appliance compute node rear panel access ports and features

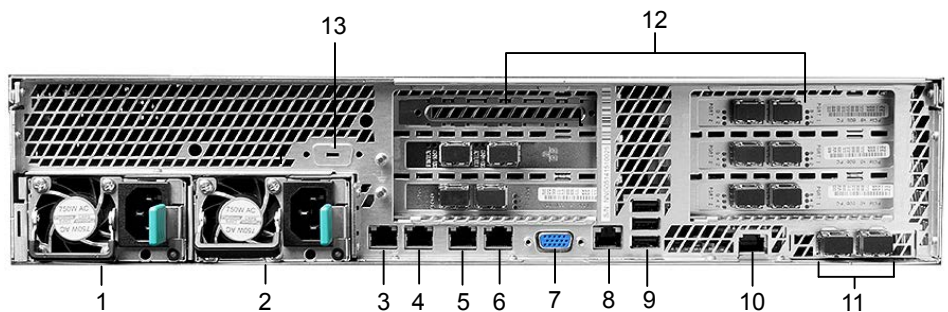

**Table 1-5** NetBackup 5330 Appliance compute node port functions

Number	Function
1,2	Power Supply Modules #1, #2 (120/220VAC)

**Table 1-5** NetBackup 5330 Appliance compute node port functions  
*(continued)*

Number	Function
3,4	NIC1/eth0 and NIC2/eth1. NIC1/eth0 is reserved for use during the initial configuration of the appliance. However, after initial configuration is complete, both NIC1/eth0 and NIC2/eth1 can be used for public networks. Both are 1GB connectors
5,6	NIC3/eth2 and NIC4/eth3 - used for public networks. Both are 1GB connectors
7	DB-15 VGA connector
8	RJ45 Serial-A port (reserved)
9	USB connectors
10	A NIC port for IPMI remote management
11	NIC5/eth4 and NIC6/eth5, left to right: 10Gb network connectors that can be used for public networks
12	Add-in PCIe adapter slots (Fibre Channel, 10Gb Ethernet)
13	Serial-B port (reserved)

The ports on the rear panel are color-coded for easy identification.

**Figure 1-5** NetBackup 5330 Appliance compute node rear port colors

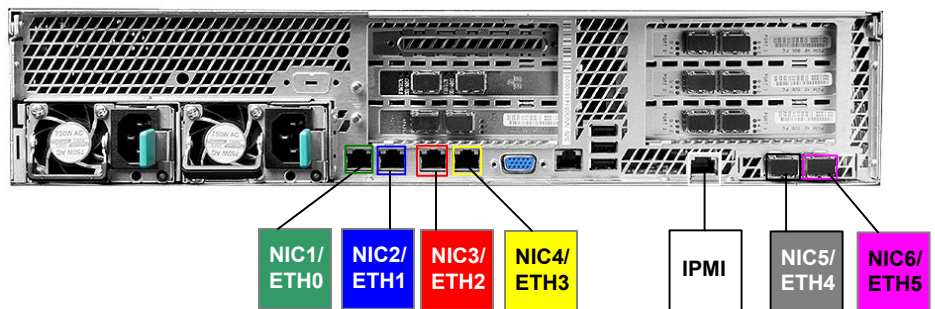

The rear panel also has two sets of low profile, full height, 3.5" form factor PCIe slots.





See “[NetBackup 5330 compute node Ethernet port configurations](#)” on page 18.

## NetBackup 5330 compute node Ethernet port configurations

The rear panel of the NetBackup 5330 compute node contains six PCIe slots, which are populated according to five different supported configurations. The PCIe slot configuration determines the number of Ethernet ports that are available.

Note the locations of each Ethernet port that is located on the rear panel of the compute node.

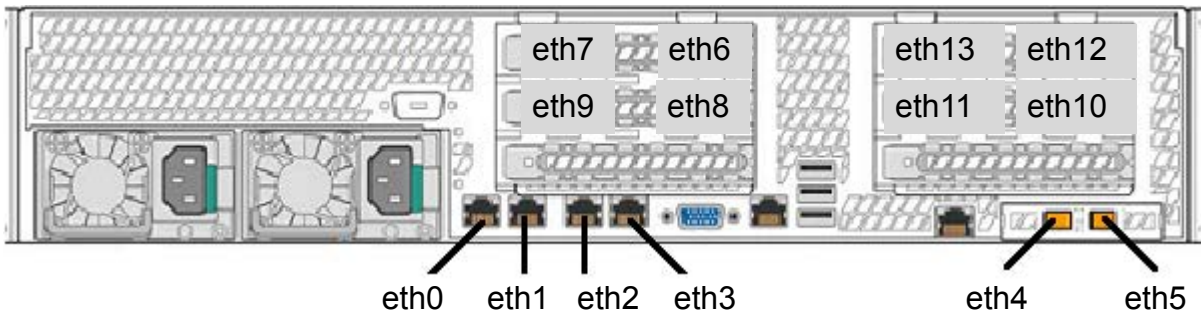

All NetBackup 5330 Appliances include the following ports, which are built in along the base of the rear panel:

- 1-GbE ports: eth0, eth1, eth2, and eth3
- 10-GbE ports: eth4 and eth5

The 10-Gb Ethernet network interface cards that are installed in the PCIe slots contain additional ports. The number of ports depends on the PCIe slot configuration of your compute node.

[Table 1-7](#) shows the available Ethernet ports for each PCIe slot configuration.

**Table 1-7** NetBackup 5330 compute node PCIe Ethernet port configurations

Option	Slot and Ethernet port numbers
A (four 10-Gb Ethernet cards)	<ul style="list-style-type: none"> <li>■ Slot 2: eth8 (right), eth9 (left)</li> <li>■ Slot 3: eth6 (right), eth7 (left)</li> <li>■ Slot 5: eth10 (right), eth11 (left)</li> <li>■ Slot 6: eth12 (right), eth13 (left)</li> </ul>
B (three 10-Gb Ethernet cards)	<ul style="list-style-type: none"> <li>■ Slot 2: eth8 (right), eth9 (left)</li> <li>■ Slot 3: eth6 (right), eth7 (left)</li> <li>■ Slot 5: eth10 (right), eth11 (left)</li> </ul>

**Table 1-7** NetBackup 5330 compute node PCIe Ethernet port configurations  
*(continued)*

Option	Slot and Ethernet port numbers
C (two 10-Gb Ethernet cards)	<ul style="list-style-type: none"> <li>■ Slot 2: eth8 (right), eth9 (left)</li> <li>■ Slot 3: eth6 (right), eth7 (left)</li> </ul>
D (one 10-Gb Ethernet card)	<ul style="list-style-type: none"> <li>■ Slot 3: eth6 (right), eth7 (left)</li> </ul>
E (no 10-Gb Ethernet cards)	N/A

## Dual-port 8 Gb Fibre Channel Host Bus Adapter (FC HBA) specifications

The Fiber Channel (FC) host bus adapter ports are used to connect the appliance to a Primary Storage Shelf, along with clients and other devices for Fibre Transport data transfer.

**Table 1-8** Dual-port 8 Gb Fibre Channel Host Bus Adapter specifications

Item	Description
Dimensions	2.54 in x 6.6 in (6.4516 cm to 16.764 cm) (low-profile)
Power consumption	Typical: 6.2 watts at 0°C to 55°C (32°F to 131°F)
Operating temperature	0°C to 55°C
Storage temperature	-40°C to +70°C (-40°F to +158°F)
Storage humidity	10% RH to 90% RH (operating, non-condensing) and 5% RH to 93% RH (non-operating, non-condensing)

## Dual-port 10 Gb Ethernet card specifications

The 10 Gb Ethernet card is available with the NetBackup 5330 Appliance. The card can be installed in the PCI Riser Assembly in addition to Fibre Channel cards.

**Table 1-9** Dual-port 10 Gb Ethernet card specifications

Item	Specification
Dimensions	2.54 in x 6.6 in (6.4516 cm to 16.764 cm) (low-profile)
Power consumption	Typical: 6.2 watts at 0°C to 55°C (32°F to 131°F)
Operating temperature	0°C to 55°C
Storage temperature	-40°C to +70°C (-40°F to +158°F)
Storage humidity	10% RH to 90% RH (operating, non-condensing) and 5% RH to 93% RH (non-operating, non-condensing)

## About NetBackup 5330 Appliance storage shelves

The NetBackup 5330 Appliance storage system supports two types of externally-connected hard disk drive-based storage shelves.

These include:

- A Primary Storage Shelf (required)
- One or more Expansion Storage Shelves (optional)

The NetBackup 5330 Appliance compute node does not contain internal storage. Instead, a required Primary Storage Shelf that uses RAID6 technology connects to the compute node as the main storage device. In addition, you can extend the RAID6 capabilities of the Primary Storage Shelf to the optional Extended Storage Shelves if you require additional storage.

The NetBackup 5330 Primary Storage Shelf and the NetBackup 5330 Expansion Storage Shelves each contain 60 SAS hard disk drives. Two of the disks are global hot spares, while four of the disks provide a dedicated RAID1 metadata volume group. The remaining 54 disks are used for data storage purposes. Both the Primary Storage Shelf and Expansion Storage Shelves contain five drawers, and each drawer contains 12 disk drives. The front panels of both systems are physically and functionally the same.

### Available appliance storage capacities

You can configure the NetBackup 5330 Appliance for use with up to 458TB of total storage capacity. The capacities of the disks within the Primary Storage Shelf and

the Expansion Storage Shelves determine the available storage capacity of the appliance. Both 3TB disks and 6TB disks are available.

---

**Note:** Individual storage shelves contain either the 3TB disks or the 6TB disks but not both.

---

The following sections explain the storage capacity options and storage configurations that are available with the different software versions of the NetBackup 5330 Appliance.

### **Storage options for a NetBackup 5330 Appliance that runs software version 2.7.1.x**

The following table shows the available storage options for NetBackup 5330 Appliances that run software version 2.7.1.x.

**Table 1-10** NetBackup 5330 Appliance version 2.7.1.x storage capacity options

<b>NetBackup 5330 Appliance (software version 2.7.1.x)</b>	<b>Primary Storage Shelf</b>	<b>Expansion Storage Shelf</b>	<b>Expansion Storage Shelf</b>	<b>Total storage capacity</b>
Configuration A	114TB	-	-	114TB
Configuration B	114TB	114TB	-	229TB
Configuration C	114TB	229TB	-	343TB
Configuration D	114TB	114TB	229TB	458TB
Configuration E	229TB	-	-	229TB
Configuration F	229TB	229TB	-	458TB

### **Storage options for a NetBackup 5330 Appliance that runs software version 2.6.x**

The following table shows the available storage options for NetBackup 5330 Appliances that run software version 2.6.x.

**Table 1-11** NetBackup 5330 Appliance version 2.6.x storage capacity options

<b>NetBackup 5330 Appliance (software version 2.6.1.x)</b>	<b>Primary Storage Shelf</b>	<b>Expansion Storage Shelf</b>	<b>Total appliance storage capacity</b>
Configuration A	114TB	-	114TB
Configuration B	114TB	114TB	229TB

### **How to increase the storage capacity for a NetBackup 5330 Appliance that runs software version 2.6.x**

You can increase the storage capacity of an existing NetBackup 5330 Appliance that runs software version 2.6.x by adding a 229TB capacity Expansion Storage Shelf. Before you add the 229TB Expansion Storage Shelf however, you must first upgrade the appliance software to version 2.7.1.x. Total appliance storage capacity then increases up to 458TBs after you complete the software upgrade and then add the higher capacity storage shelf.

**Table 1-12** NetBackup 5330 Appliance storage capacity options after upgrading from software version 2.6.x to version 2.7.1.x

<b>NetBackup 5330 Appliance (software version 2.7.1.x)</b>	<b>Primary Storage Shelf</b>	<b>Expansion Storage Shelf</b>	<b>Expansion Storage Shelf</b>	<b>Total storage capacity</b>
Configuration C	114TB	229TB*	-	343TB
Configuration D	114TB	114TB	229TB*	458TB

\* Upgrade the appliance software version from 2.6.x to 2.7.1.x before you add the second Expansion Storage Shelf that uses 6TB disks.

## About the NetBackup 5330 Appliance Primary Storage Shelf and Expansion Storage Shelf front panel

The NetBackup 5330 Appliance Primary Storage Shelf and Expansion Storage Shelf each contain 60 SAS hard disk drives. The front panel of the Primary Storage Shelf and Expansion Storage Shelf contain five drawers. The drawers are numbered one through five, beginning with the top drawer. Each storage shelf drawer contains 12 disk drives. The front panels of both systems are physically and functionally the same, as seen in the following diagram.

**Figure 1-6** Primary Storage Shelf and Expansion Storage Shelf front panel



The following table shows the front panel LEDs in detail.

**Figure 1-7** Disk system front panel LEDs

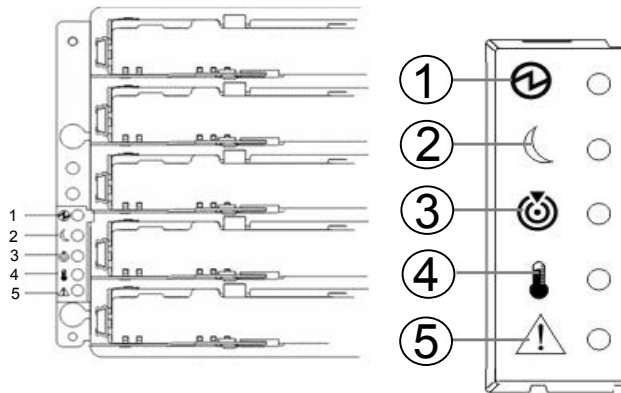

The following table describes LEDs available on the disk system front panel.

**Table 1-13** Primary Storage Shelf and Expansion Storage Shelf front panel LED definitions

Number	Definition	Color
1	Power LED	Green
2	Standby Power LED	Green
3	Locate LED	White
4	Over-temperature LED	Amber
5	Service Action Required LED	Amber

As mentioned, each drawer in a storage shelf contains slots for 12 disks. The slots are numbered as shown in the following diagram.

**Figure 1-8** Drawer disk layout



## About the NetBackup 5330 Appliance Primary Storage Shelf and Expansion Storage Shelf rear panels

The NetBackup 5330 Appliance Primary Storage Shelf and the Expansion Storage Shelf includes two power cords that should be plugged into the appropriate external power source within a rack. When connecting power cables, wear an ESD-preventive wrist strap to prevent equipment damage.

The rear panel of both disk systems contains three types of canisters:

- RAID or Expansion canisters
- AC power canisters (220VAC)
- Fan canisters

The Primary Storage Shelf has two RAID canisters, which are inserted in the central slots of the back panel. The power supplies are inserted at the top and bottom of the back panel, and the fans are on either side. The RAID canisters are attached to the NetBackup 5330 Appliance with fiber optic cables. The device must have at least one functioning RAID canister, one functioning power supply, and one functioning fan.

The following figure shows the Primary Storage Shelf rear panel.



**Figure 1-9** Primary Storage Shelf rear panel



**Note:** Latches that let you remove the canisters are circled in red.

**Table 1-14** Primary Storage Shelf rear panel components

Number	Description
1	Fan canisters
2 and 5	Power canisters
3 and 4	RAID controller canisters

Each RAID canister has a set of LEDs which are defined in the following figure. The table describes the LEDs functions and colors. The LEDs labeled '1' track the data rate of the link. If both are off, the link is inactive, and if both are on, the data rate is 8 Gb per second. If only one LED is on, the LED on the left indicates a 2 Gb/s data rate, and the one on the right indicates a 4 Gb/s data rate. The canister also displays the ID of the Primary Storage Shelf, which is set to '99'.

**Figure 1-10** RAID canister LEDs

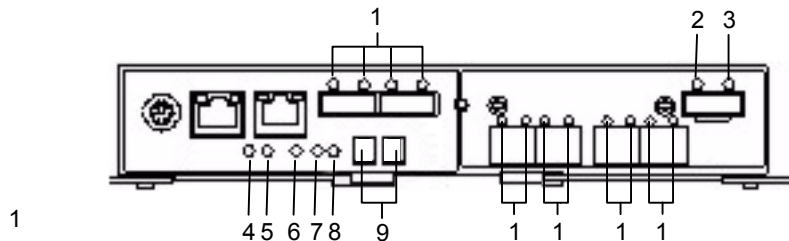
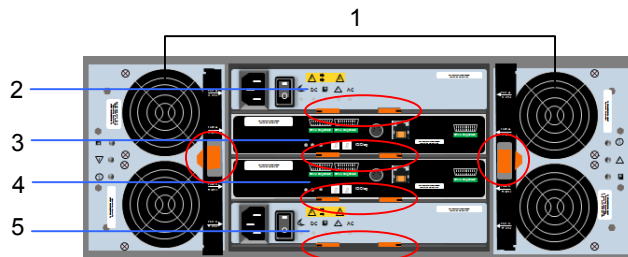

**Table 1-15** RAID canister LEDs

Number	Description	Color
1	Data link activity	Green
2	SAS expansion fault	Amber
3	SAS expansion active	Green
4	Battery service action required	Amber
5	Battery charging	Green
6	RAID service system action allowed	Blue
7	RAID service system action required	Amber
8	Cache active	Green
9	Seven-segment display LEDs for system ID	Displays '99'

The Expansion Storage Shelf also contains two fans, on either side, and two power supplies, in the top and the bottom slots. The power supplies should be connected to the Power Distribution Units (PDU), which must be connected to an external 240V power supply. The two center slots contain expansion canisters, one of which must always function. The Expansion Storage Shelf must be attached to a Primary Storage Shelf by SAS cables, plugged into the expansion canisters.

**Figure 1-11** Expansion Storage Shelf rear panel



**Table 1-16** Expansion Storage Shelf rear panel components

Number	Description
1	Fan canisters
2 and 5	Power canisters
3 and 4	Expansion canisters

The following diagram shows the LEDs in the Expansion Storage Shelf canister, along with the SAS ports. It also gives the location of the tray ID that is displayed when the system is initialized. The Primary Storage Shelf recognizes the Expansion Storage Shelf where the ID is set to 00.

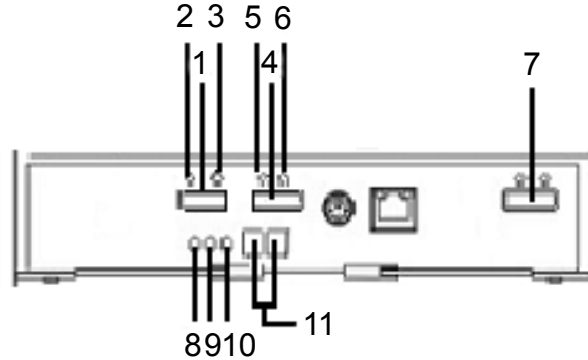

**Table 1-17** Expansion Storage Shelf rear panel features

Number	Description	LED Display
1	SAS port	n/a
2	Link fault LED	Amber
3	Data Link LED	Green
4	SAS port	n/a
5	Link fault LED	Amber
6	Data Link LED	Green
7	SAS port	n/a
8	Service action allowed LED	Blue
9	Service action required LED	Amber

**Table 1-17** Expansion Storage Shelf rear panel features (*continued*)

Number	Description	LED Display
10	Power LED	Green
11	Seven-segment display LEDs for system ID	00

As seen in both diagrams, the seven-segment display LEDs shows the storage system ID, once the devices have been turned on and are recognized. The following diagram shows the location of these displays, as seen on the rear panel of the Primary Storage Shelf, which are circled in red.

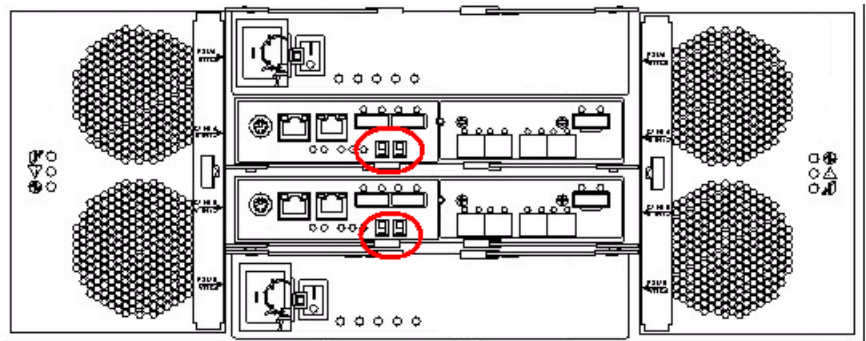

**IMPORTANT:** Notice that both systems have identical power supply canisters and fan canisters. However, the Primary Storage Shelf contains RAID controller canisters. The Extension Storage Shelf contains expansion canisters instead of RAID canisters. The following figure provides a comparison of the two canister types.

**Figure 1-12** Comparison of the Primary Storage Shelf and Extension Storage Shelf canisters

### Primary Storage Shelf



### Expansion Storage Shelf

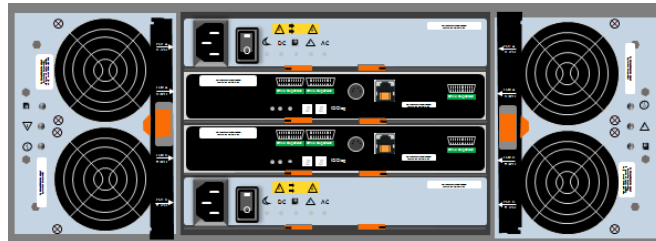

Primary Storage  
Shelf RAID  
canister  
(enlarged)



Fibre channel  
ports

SAS  
ports

Expansion  
Storage Shelf  
canister  
(enlarged)



## Best practices for rack installation

The heaviest equipment should be installed at the bottom of a rack. The heavy devices that are installed at the top of a rack make the rack "top-heavy", or unstable. Unstable racks jeopardize staff and equipment safety and are subject to risk.

When you install more than one device per rack, do the following:

- Find out how much each device weighs.

---

**Note:** A storage device is heavier than an appliance and must always be installed under the appliance.

---

- Determine device order and cabling limits.
- Be aware of the depth of the guide rails and the devices. Ensure that the distance between cabinet posts accommodates the rails and devices.
  - The rack rails that are provided for the storage shelf are extensible to 36" (914mm). This distance is the maximum depth that is allowed between rack posts. If the distance between rack posts is longer than 36" (914mm) the

rails and the appliance cannot be properly installed. The width of the storage shelf is 19" (482.6mm).

If your rack dimensions do not conform to these requirements contact technical support.

# NetBackup 5330 Appliance cables

This chapter includes the following topics:

- [Power cables](#)
- [Network cable](#)
- [Multi-Mode fibre cable](#)
- [SAS cable](#)

## Power cables

Each AC power module of the appliance and of the storage device is configured with one AC power cable. One end of the AC power cable is connected to the power socket on the appliance or the storage device. The other end of the cable is connected to the external power supply.

---

**Note:** Power cables vary in different regions. Standard international cables are used as an example in this document.

---



**Figure 2-1** AC power cable

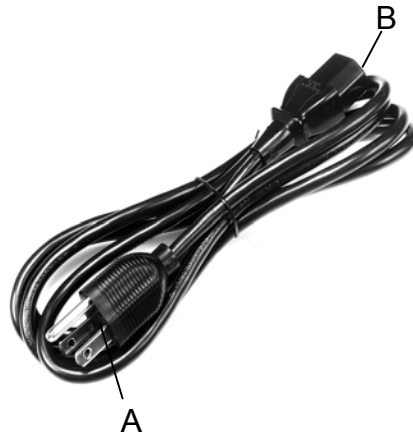

A AC power connector to wall outlet.

B AC power connector to an appliance or a storage device.

---

**Note:** This figure shows an example of possible connectors. Actual connectors vary per country.

---

A power cable includes live line, neutral line, and grounding lines.

## Network cable

The NetBackup 5330 Appliance communicates with the outside through an Ethernet network cable. One end of the network cable connects to the management network port or service network port of the appliance. The other end of the cable connects to the network switch or an external gateway. Both ends of the cable are RJ-45 connectors.

**Figure 2-2** Network cable

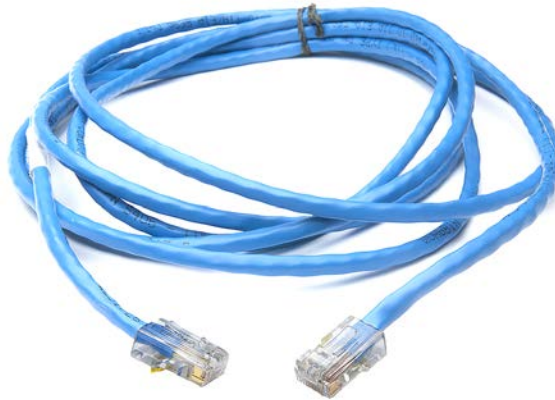

## Multi-Mode fibre cable

The NetBackup 5330 Appliance communicates with the fiber channel switch through a multi-mode fibre cable. One end of the multi-mode fibre cable connects to the 10GE service network port or the fibre channel port. The other end of the cable connects to the fiber channel switch or other devices. The two ends of the multi-mode fibre are LC connectors.

**Figure 2-3** Multi-Mode fibre cable

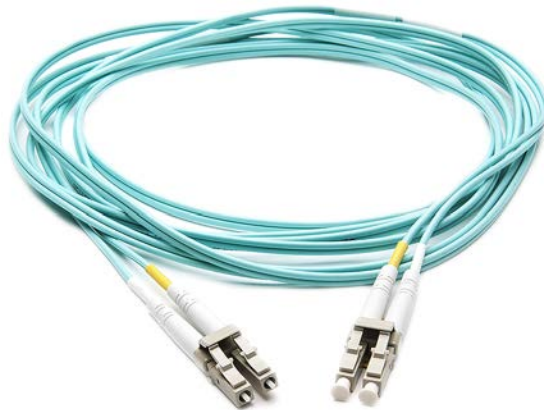

Fiber optic cables require Small Form-factor Pluggable (SFP+) transceivers, which are provided with each device having Fibre Channel ports. The diagram shows the SFP, labeled 1, and the fiber optic cable which is attached to it, labeled 2.

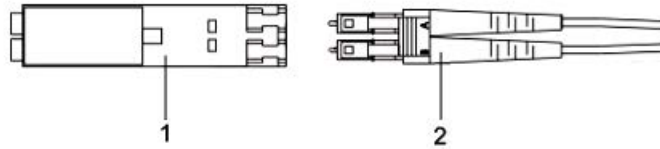

Supported SFPs are listed:

- Finisar
- JDSU

## SAS cable

A SAS cable has a SAS connector on both ends. Two SAS cables ship with each Expansion Storage Shelf.

**Figure 2-4** SAS cable



Refer to NetBackup 5330 Appliance and storage shelf connection sections as needed for details.

# Technical specifications, standards, and compliance information

This appendix includes the following topics:

- [NetBackup 5330 Appliance system technical specifications](#)
- [Environmental specifications](#)
- [Protocol standards](#)
- [Regulatory, compliance, and certification information](#)

## NetBackup 5330 Appliance system technical specifications

---

**Note:** The maximum weight of the NetBackup 5330 Appliance includes the eight disk drive modules, eight disk drive carriers, and two power modules.

---

---

**Note:** The maximum weight of the storage shelves includes 60 disk drive slots, two power canisters, and two fan canisters.

---

---

**Note:** The transportation weight is the sum of the maximum weight of a device and the maximum weight of the transportation materials.

---

**Table A-1** NetBackup 5330 Appliance specifications

Parameter	Description
Rack information	The rack installation height is the space occupied by an appliance in a rack cabinet. The rack height for the appliance is 2U (1U = 44.5 cm). Install the appliance in a rack cabinet that is 19 inches (1 inch = 2.54 cm) wide and 39.37 inches (100 cm) deep, or deeper.
Weight	Weight: approximately 30 kg (66 lbs)
Dimensions	Height: 8.76 cm (3.45") (approximately 2U) Width: 43.8 cm (17.24") Depth: 69.59 cm (27.39")
Power consumption	750 watts maximum
AC power requirements	110 VAC or 220 VAC 100 - 110 VAC at 50/60 Hz 8.2 A 200 - 220 VAC at 50/60 Hz 4.4 A
Inherent availability of the system	≥ 99.95%
Mean Time to Repair (MTTR)	1 hour
Operating temperature	+10°C to +35°C with the maximum rate of change not to exceed 10°C per hour
Non-operating temperature	-40°C to +70°C
Non-operating humidity	90%, non-condensing at 35°C
Acoustic noise	Sound power: 7.0 dB in operating condition at typical office ambient temperature. (23°C +/- 2)
System Cooling Requirement	460 watts maximum – 1570 BTU/hour 750 watts maximum – 2559 BTU/hour

The technical specifications for the NetBackup 5330 Appliance Primary Storage Shelf and for the NetBackup 5330 Appliance Expansion Storage Shelf are as follows.

**Table A-2** Primary Storage Shelf and Expansion Storage Shelf technical specifications

Parameter	Description
Rack information	4U
Weight	Approximately 105.2 kg (232 lb) with the 60 disk drives installed Approximately 80 kg (176 lb) without the disk drives
Dimensions	Height: 82.55 cm (32.50") (approximately 4U) Width: 48.28 cm (19.00") Depth: 17.78 cm (7.00")
Overall maximum AC currents (agency ratings)	7.56 A at 200 VAC 6.3 A at 240 VAC
AC power requirements	Input voltage: 200 - 240 VAC Frequency: Range 50 Hz to 60 Hz Typical operating current: Range 4.9 A to 5.75 A Nameplate rating: Range 6.3 A to 7.56 A
Primary Storage Shelf Power ratings and heat dissipation including two fan canisters, two power canisters, 60 disk drives, and two RAID canisters.	Watts: 1135 AC (typical) Watts: 1222 AC (maximum) Cooling BTU/hr: 3873 (typical) Cooling BTU/hr: 4180 (maximum)
Expansion Storage Shelf Power ratings and heat dissipation including two fan canisters, two power canisters, 60 disk drives, and two expansion canisters.	Watts: 847 AC (typical) Watts: 1222 AC (maximum) Cooling BTU/hr: 2890 (typical) Cooling BTU/hr: 4180 (maximum)
NetBackup 5330 compute node with a Primary Storage Shelf connected Total storage capacity: 114TB	Watts: 1595 watts (typical) Watts: 1972 watts (maximum) Cooling BTU/hr: 5442 (typical) Cooling BTU/hr: 6739 (maximum)

**Table A-2** Primary Storage Shelf and Expansion Storage Shelf technical specifications (*continued*)

Parameter	Description
NetBackup 5330 compute node with both a Primary Storage Shelf and an Expansion Storage Shelf connected	Watts: 2442 (typical) Watts: 3194 (maximum)
Total storage capacity: 229TB	Cooling BTU/hr: 8332 (typical) Cooling BTU/hr: 10919 (maximum)
Sound levels	Sound power (standby operation): 6.5 bels Sound power (normal operation): 6.8 bels Sound pressure: 68 dB

## Environmental specifications

The following table lists the requirements for the NetBackup 5330 Appliance and the storage shelves.

**Table A-3** Environmental specifications

Component	Requirement
Operating temperature	10°C to 35°C (41°F to 95°F)
Storage temperature	-40°C to 70°C (-40°F to 158°F)
Transportation temperature	-40°C to 70°C (-40°F to 158°F)
Temperature gradient	10°C/h
Operating humidity	10%RH to 85%RH
Operating altitude	-30 meters to 3,000 meters  In altitudes from -60 meters to +1,800 meters, the ambient temperature ranges from 5°C to 35°C. When the altitude ranges from 1,800 meters to 3,000 meters, the environment temperature decreases by 0.6°C when the altitude increases by 100 meters.
Storage altitude	-30 meters to 3,000 meters

**Table A-3** Environmental specifications (*continued*)

Component	Requirement
Noise	< 72 A-weighted decibel  This value reflects the maximum noise of the appliance when the ambient temperature is 25°C.

## Protocol standards

The following table provides standards with which the NetBackup 5330 Appliance and storage shelves comply.

**Table A-4** Standards compliance

Standard	Version
IPMI 2.0	Intelligent Platform Management Interface Specification Second Generation v2.0, Document Revision 1.0
SMBIOS	System Management BIOS (SMBIOS) Reference Specification, Version 2.5
SAS	SAS- 2.1
ACPI	Advanced Configuration and Power Interface Specification, Revision 3.0, September 2
IP	RFC0791: Internet Protocol
FC	INCITS T11 (X3T9.3)
PCI Express	PCIe 3.0

## Regulatory, compliance, and certification information

Refer to the *NetBackup™ Appliance Safety and Maintenance Guide* on the following website for detailed information:

<https://www.veritas.com/docs/DOC2792>



# Index

## A

- appliance
  - control panel descriptions 14
  - disk drive LED descriptions 14
  - Fibre Channel HBA support 11
  - fibre channel host bus adapter 19
  - front panel
    - LED descriptions 13
  - performance and capacity 10
  - Primary and Expansion storage shelf storage capacities 10
  - RAID cache specification 10
  - RAID specifications 11
  - rear panel 15
  - rear panel port components 11
  - rear panel port functions 16
  - rear panel ports and features 15
  - rear port color assignments 16
  - system features 11
  - system memory configuration 10
- appliance compute node
  - disk drive layout 12
  - PCIe options 17
  - slot assignments and RAID disk assignments 13

## C

- cables
  - multi-mode fibre
    - description 34
  - network
    - description 33
  - power
    - description 32
  - SAS
    - description 35

## D

- disk drive layout
  - appliance compute node 12

## E

- Ethernet card
  - dual-port 10GB card specifications 19
- Ethernet ports
  - NetBackup 5330 configurations 18
- Expansion Storage Shelf
  - about 20
  - drawer disk layout 24
  - expansion canisters 27
  - fan canisters 27
  - front panel descriptions 22
  - front panel LED definitions 23
  - power canisters 27
  - rear panel components 27
  - rear panel features 28

## F

- fibre channel host bus adapter 19

## N

- NetBackup 5330 Appliance technical specifications 36

## P

- PCIe options 17
- PCIe slot configurations 17
- Primary Storage Shelf
  - about 20
  - disk drive layout 22
  - drawer disk layout 24
  - fan canisters 25
  - front panel descriptions 22
  - front panel LED definitions 23
  - power canisters 25
  - RAID controller canister LED descriptions 25
  - RAID controller canisters 25
  - rear panel components 25
- Primary Storage Shelf and Expansion Storage Shelf comparison 29
- Primary Storage Shelf and Expansion Storage Shelf technical specifications 39

**R**

- rack installation
  - best practices 30
- RAID disk assignments
  - appliance compute node 13
- regulatory, compliance, and certification information 40

**S**

- slot assignments
  - appliance compute node 13
- specifications
  - environmental 39
- standards
  - protocol 40
- storage shelf drawer disk layout 24
- system features 11